

MOTOTRBO™ PORTABLE
PROFESSIONAL DIGITAL TWO-WAY RADIO



MOTOTRBO™ PORTABLE
XPR 3000e Series BASIC
SERVICE MANUAL

DECEMBER 2017

© 2017 Motorola Solutions, Inc. All rights reserved



MN002209A01-AB

Contents

List of Figures.....	5
List of Tables.....	7
Foreword.....	9
Product Safety and RF Exposure Compliance.....	9
Computer Software Copyrights.....	9
Document Copyrights.....	9
Disclaimer.....	9
Trademarks.....	10
Document History.....	11
Notations Used in This Manual.....	12
Commercial Warranty.....	13
I. What This Warranty Covers And For How Long.....	13
II. General Provisions.....	13
III. State Law Rights (Applicable Only in U.S.A.).....	14
IV. How To Get Warranty Service.....	14
V. What This Warranty Does Not Cover.....	14
VI. Patent And Software Provisions.....	14
VII. Governing Law.....	15
Battery and Charger Warranty.....	16
Chapter 1: Introduction.....	17
1.1 Radio Description.....	17
1.1.1 Limited Keypad Model.....	18
1.1.2 Non-Keypad Model.....	20
1.2 Portable Radio Model Numbering Scheme.....	21
1.3 Model Charts.....	22
1.3.1 UHF Model Chart.....	22
1.3.2 VHF Model Chart.....	23
1.4 Specifications.....	23
Chapter 2: Test Equipment and Service Aids.....	29
2.1 Recommended Test Equipment.....	29
2.2 Service Aids.....	30
2.3 Programming, Testing, and Alignment Cable.....	32
Chapter 3: Transceiver Performance Testing.....	35
3.1 Setup.....	35
3.1.1 Setting Up DMR Transmitter and Receiver Test.....	35

3.2 Display Model Test Mode.....	36
3.2.1 Entering Display Radio Test Mode.....	36
3.2.2 RF Test Mode.....	37
3.2.2.1 Testing RF Channel Selections.....	37
3.2.3 Display Test Mode.....	40
3.2.4 LED Test Mode.....	41
3.2.5 Backlight Test Mode.....	41
3.2.6 Speaker Tone Test Mode.....	41
3.2.7 Earpiece Tone Test Mode.....	41
3.2.8 Audio Loopback Earpiece Test Mode.....	42
3.2.9 Battery Check Test Mode.....	42
3.2.10 Button/Knob/PTT Test Mode.....	42
3.3 Non-Display Model Test Mode.....	44
3.3.1 Entering Non-Display Radio Test Mode.....	44
3.3.2 RF Test Mode.....	44
3.3.2.1 Testing RF Channel Selections.....	44
3.3.3 LED Test Mode.....	48
3.3.4 Speaker Tone Test Mode.....	48
3.3.5 Earpiece Tone Test Mode.....	48
3.3.6 Audio Loopback Earpiece Test Mode.....	49
3.3.7 Battery Check Test Mode.....	49
3.3.8 Button/Knob/PTT Test Mode.....	49
Chapter 4: Radio Programming and Tuning.....	50
4.1 Customer Programming Software Setup.....	50
4.2 AirTracer Application Tool.....	51
4.3 Radio Tuning Setup.....	51
4.3.1 RF Plug Disassembly.....	51
Chapter 5: Disassembly/Reassembly Procedures.....	54
5.1 Preventive Maintenance.....	54
5.2 Safe Handling of CMOS and LDMOS Devices.....	55
5.3 General Repair Procedures and Techniques.....	56
5.4 Disassembling and Reassembling the Radio.....	57
5.5 Torque Chart.....	57
5.6 Detailed Radio Disassembly.....	58
5.6.1 Front Kit from Chassis Disassembly.....	58
5.6.2 Back Kit Disassembly.....	63
5.6.3 Keypad, Display, and Keypad Board Disassembly.....	64
5.6.4 Side Button, Speaker, Microphone, and UC-Audio Flex Disassembly.....	67
5.7 Detailed Radio Reassembly.....	70

5.7.1 Speaker Reassembly.....	70
5.7.2 Side Button, Keypad, Display, and Keypad Board Reassembly.....	72
5.7.3 Back Kit Reassembly.....	76
5.7.4 Front Kit Reassembly.....	79
5.7.5 RF Plug Reassembly.....	82
5.8 Ensuring Radio Immersibility.....	84
5.8.1 Servicing.....	84
5.8.2 Accidental Immersion.....	84
5.8.3 Specialized Test Equipment.....	84
5.8.4 Vacuum Pump Kit.....	84
5.8.5 Pressure Pump Kit.....	85
5.8.6 Miscellaneous Hardware.....	85
5.8.7 Vacuum Test.....	85
5.8.8 Pressure Test.....	86
5.8.9 Troubleshooting Leak Areas.....	87
5.8.9.1 Front Housing Troubleshooting.....	87
5.8.9.2 Replacing Battery Contact Seal.....	87
5.8.9.3 Replacing Chassis Assembly.....	88
5.8.9.4 Replacing Ventilation Seal and Ventilation Label.....	88
5.8.9.5 Battery Maintenance.....	88
5.8.10 Troubleshooting Charts.....	90
5.9 Radio Exploded Mechanical View and Parts List.....	93
5.9.1 Limited Keypad Model.....	93
5.9.2 Non-Keypad Model.....	96
5.9.3 Additional Parts List.....	98
Chapter 6: Basic Troubleshooting.....	100
6.1 Replacement Back Cover Kit Procedures.....	100
6.2 Power-Up Error Codes.....	100
6.3 Operational Error Codes.....	102
Chapter 7: Authorized Accessories List.....	103
Chapter 8: Replacement Parts Ordering.....	107
Chapter 9: Motorola Solutions Service Centers.....	109
Chapter 10: Limited Level 3 Servicing.....	110
10.1 Component and Parts List.....	111
Glossary.....	113

List of Figures

Figure 1: Limited Keypad Model.....	18
Figure 2: Non-Keypad Model.....	20
Figure 3: Programming, Testing, and Alignment Cable.....	33
Figure 4: Pin Layout of Side Connector.....	34
Figure 5: DMR Radio Transmitter and Receiver Testing Setup.....	36
Figure 6: Battery Check Test Mode Display.....	42
Figure 7: CPS Programming Setup.....	50
Figure 8: Radio Tuning Equipment Setup.....	51
Figure 9: RF Plug disassembly.....	52
Figure 10: RF Adaptor insertion.....	52
Figure 11: RF Adaptor screw.....	53
Figure 12: RF Connector.....	53
Figure 13: Battery removal.....	59
Figure 14: Battery removal.....	59
Figure 15: Antenna removal.....	60
Figure 16: Volume and Channel Knob removal.....	60
Figure 17: Front Kit-Back Kit Screw removal.....	61
Figure 18: Back Kit disassembly.....	61
Figure 19: Back Kit removal.....	62
Figure 20: Disconnecting the interface UC-audio flex and keypad-display flex (Limited Keypad Model).....	62
Figure 21: Disconnecting the UC-audio flex (Non-Keypad Model).....	63
Figure 22: Top control seal removal.....	63
Figure 23: Back Kit disassembly.....	64
Figure 24: Battery contact seal removal.....	64
Figure 25: UC-audio flex removal.....	65
Figure 26: K18 screw removal.....	65
Figure 27: Display flex removal.....	66
Figure 28: Keypad removal.....	66
Figure 29: PTT retainer removal.....	67
Figure 30: Side button removal.....	68
Figure 31: UC escutcheon removal.....	68
Figure 32: UC-audio flex removal.....	69
Figure 33: Speaker retainer screw removal.....	69
Figure 34: Speaker retainer removal.....	70
Figure 35: Speaker assembly.....	70

Figure 36: UC-audio flex.....	71
Figure 37: UC escutcheon.....	71
Figure 38: Speaker retainer reassembly.....	72
Figure 39: Side button reassembly.....	73
Figure 40: PTT retainer reassembly.....	73
Figure 41: Display module reassembly.....	74
Figure 42: Keypad reassembly.....	74
Figure 43: Keypad board reassembly.....	75
Figure 44: Display flex reassembly.....	75
Figure 45: Speaker retainer reassembly.....	76
Figure 46: UC-audio flex pad reassembly.....	76
Figure 47: Replace thermal pad.....	77
Figure 48: Affix chassis label.....	77
Figure 49: Battery contact seal reassembly.....	78
Figure 50: Mainboard reassembly.....	78
Figure 51: Top control seal reassembly.....	79
Figure 52: Interface flexes reassembly (Limited Keypad Model).....	80
Figure 53: Interface flexes reassembly (Non-Keypad Model).....	80
Figure 54: Front kit reassembly.....	81
Figure 55: Knob reassembly.....	81
Figure 56: Attaching the antenna.....	82
Figure 57: RF Plug reassembly.....	82
Figure 58: Nameplate replacement.....	83
Figure 59: Product nameplate reassembly.....	83
Figure 60: Connector Fitting - Fitting Seal Pump Connector.....	85
Figure 61: Troubleshooting Flow Chart for Vacuum Test (Sheet 1 of 2).....	90
Figure 62: Troubleshooting Flow Chart for Vacuum Test (Sheet 2 of 2).....	91
Figure 63: Troubleshooting Flow Chart for Pressure Test and Leakage Areas.....	92
Figure 64: Limited Keypad Model Exploded View.....	93
Figure 65: Non-Keypad Model Exploded View.....	96
Figure 66: PCB Top View.....	111
Figure 67: PCB Bottom View.....	112

List of Tables

Table 1: Radio Frequency Ranges and Power Levels.....	17
Table 2: Portable Radio Model Numbering Scheme.....	21
Table 3: Sales Models – Description of Symbols.....	21
Table 4: XPR 3000e Series, UHF, 403–512 MHz Model Chart.....	22
Table 5: XPR 3000e Series, VHF, 136–174 MHz Model Chart.....	23
Table 6: General Specifications.....	23
Table 7: Receiver Specifications.....	24
Table 8: Transmitter Specifications.....	25
Table 9: Self-Quieter Frequencies.....	26
Table 10: Military Standards.....	27
Table 11: Environmental Specifications.....	28
Table 12: Test Equipments.....	29
Table 13: Service Aids.....	30
Table 14: Pin Configuration of Side Connector.....	33
Table 15: Initial Equipment Control Settings.....	35
Table 16: Front Panel Access Test Mode Displays.....	36
Table 17: Test Environments.....	37
Table 18: Test Frequencies.....	38
Table 19: Transmitter Performance Checks.....	38
Table 20: Receiver Performance Checks.....	39
Table 21: Button/Knob/PTT Checks.....	42
Table 22: Keypad Checks.....	43
Table 23: Test Environments.....	45
Table 24: Test Frequencies.....	45
Table 25: Transmitter Performance Checks.....	46
Table 26: Receiver Performance Checks.....	47
Table 27: Button/Knob/PTT Checks.....	49
Table 28: Software Installation Kits Radio Tuning Setup.....	50
Table 29: Lead Free Solder Wire Part Number List.....	56
Table 30: Lead Free Solder Paste Part Number List.....	56
Table 31: Torque Specifications for Screws.....	57
Table 32: Limited Keypad Model Exploded View Parts List.....	93
Table 33: Non Keypad Model Exploded View Parts List.....	96
Table 34: Batteries.....	98
Table 35: Nameplates.....	98
Table 36: Back Kits.....	98

Table 37: Antenna ID Band (in pack of 10 pieces).....	99
Table 38: Belt Clips.....	99
Table 39: Types of Error Code.....	101
Table 40: Types of Error Code.....	102
Table 41: Component Parts List.....	112

Foreword

This manual includes all the information necessary to maintain peak product performance and maximum working time, using levels 1 and 2 maintenance procedures.

This level of service goes down to the board replacement level and is typical of some local service centers, Motorola Solutions authorized dealers, self-maintained customers, and distributors.



CAUTION: These servicing instructions are for the use of qualified personnel only. To reduce the risk of electric shock, do not perform any servicing other than that contained in the Operating Instructions unless you are qualified to do so. Refer all servicing to qualified service personnel.

Product Safety and RF Exposure Compliance



CAUTION: Before using this product, read the Product Safety and RF Exposure booklet enclosed with your radio which contains important operating instructions for safe usage and RF energy awareness and control for Compliance with applicable Standards and Regulations.

For a list of Motorola Solutions-approved antennas, batteries, and other accessories, visit the following web site: <http://www.motorolasolutions.com>

Computer Software Copyrights

The Motorola Solutions products described in this manual may include copyrighted Motorola Solutions computer programs stored in semiconductor memories or other media. Laws in the United States and other countries preserve for Motorola Solutions certain exclusive rights for copyrighted computer programs, including, but not limited to, the exclusive right to copy or reproduce in any form the copyrighted computer program. Accordingly, any copyrighted Motorola Solutions computer programs contained in the Motorola Solutions products described in this manual may not be copied, reproduced, modified, reverse-engineered, or distributed in any manner without the express written permission of Motorola Solutions. Furthermore, the purchase of Motorola Solutions products shall not be deemed to grant either directly or by implication, estoppel, or otherwise, any license under the copyrights, patents or patent applications of Motorola Solutions, except for the normal non-exclusive license to use that arises by operation of law in the sale of a product.

Document Copyrights

No duplication or distribution of this document or any portion thereof shall take place without the express written permission of Motorola Solutions. No part of this manual may be reproduced, distributed, or transmitted in any form or by any means, electronic or mechanical, for any purpose without the express written permission of Motorola Solutions.

Disclaimer

The information in this document is carefully examined, and is believed to be entirely reliable. However, no responsibility is assumed for inaccuracies. Furthermore, Motorola Solutions reserves the right to make changes to any products herein to improve readability, function, or design. Motorola Solutions does not assume any liability arising out of the applications or use of any product or circuit described herein; nor does it cover any license under its patent rights nor the rights of others.

Trademarks

MOTOROLA, MOTO, MOTOROLA SOLUTIONS and the Stylized M logo are trademarks or registered trademarks of Motorola Trademark Holdings, LLC and are used under license. All other trademarks are the property of their respective owners.

© 2017 Motorola Solutions, Inc. All rights reserved.

Document History

The following major changes have been implemented in this manual since the previous edition:

Edition	Description	Date
MN002209A01-AA	Initial Release	January 2016
MN002209A01-AB	Added battery information for PMNN4543_ and PMNN4544_ to General Specifications, Additional Parts List and Accessories sections. Updated Self Quieter Frequencies in Specification section.	December 2017

Notations Used in This Manual

Throughout the text in this publication, you will notice the use of warning, caution, and notice notations. These notations are used to emphasize that safety hazards exist, and due care must be taken and observed.



WARNING: WARNING indicates a potentially hazardous situation which, if not avoided, could result in death or injury.



CAUTION: CAUTION indicates a potentially hazardous situation which, if not avoided, might result in equipment damage.



NOTICE: NOTICE indicates an operational procedure, practice, or condition that is essential to emphasize.

Commercial Warranty

Limited Warranty

Motorola Solutions Communication Products

I. What This Warranty Covers And For How Long

Motorola Solutions Inc. ("Motorola Solutions") warrants the Motorola Solutions manufactured Communication Products listed below ("Product") against defects in material and workmanship under normal use and service for a period of time from the date of purchase as scheduled below:

The radios additionally ship with a standard 1-year Repair Service Advantage (RSA) (for U.S. customers) or 1-year Extended Warranty (for Canada customers). However, at the time of order, you may choose to omit these warranties. For more RSA or Extended Warranty information, please refer to the price pages or Motorola Online (<https://businessonline.motorolasolutions.com>) > Resource Center > Services > Service Product Offerings > Repair Service Advantage or Extended Warranty.

Motorola Solutions, at its option, will at no charge either repair the Product (with new or reconditioned parts), replace it (with a new or reconditioned Product), or refund the purchase price of the Product during the warranty period provided it is returned in accordance with the terms of this warranty. Replaced parts or boards are warranted for the balance of the original applicable warranty period. All replaced parts of Product shall become the property of Motorola Solutions.

This express limited warranty is extended by Motorola Solutions to the original end user purchaser only and is not assignable or transferable to any other party. This is the complete warranty for the Product manufactured by Motorola Solutions. Motorola Solutions assumes no obligations or liability for additions or modifications to this warranty unless made in writing and signed by an officer of Motorola Solutions. Unless made in a separate agreement between Motorola Solutions and the original end user purchaser, Motorola Solutions does not warrant the installation, maintenance or service of the Product.

Motorola Solutions cannot be responsible in any way for any ancillary equipment not furnished by Motorola Solutions which is attached to or used in connection with the Product, or for operation of the Product with any ancillary equipment, and all such equipment is expressly excluded from this warranty. Because each system which may use the Product is unique, Motorola Solutions disclaims liability for range, coverage, or operation of the system as a whole under this warranty.

II. General Provisions

This warranty sets forth the full extent of Motorola Solutions responsibilities regarding the Product. Repair, replacement or refund of the purchase price, at Motorola Solutions option, is the exclusive remedy.

This warranty is given in lieu of all other express warranties, implied warranties, including without limitation, implied warranties of merchantability and fitness for a particular purpose, are limited to the duration of this limited warranty. In no event shall Motorola Solutions be liable for damages in excess of the purchase price of the product, for any loss of use, loss of time, inconvenience, commercial loss, lost profits or savings or other incidental, special or consequential damages arising out of the use or inability to use such product, to the full extent such may be disclaimed by law.

III. State Law Rights (Applicable Only in U.S.A.)

Some states do not allow the exclusion or limitation of incidental or consequential damages or limitation on how long an implied warranty lasts, so the above limitation or exclusions may not apply.

This warranty gives specific legal rights, and there may be other rights which may vary from state to state.

IV. How To Get Warranty Service

You must provide proof of purchase (bearing the date of purchase and Product item serial number) in order to receive warranty service and, also, deliver or send the Product item, transportation, and insurance prepaid, to an authorized warranty service location.

Warranty service will be provided by Motorola Solutions through one of its authorized warranty service locations. If you first contact the company which sold you the Product, it can facilitate your obtaining warranty service.

You can also call Motorola Solutions at 1-800-927-2744 US/Canada.

V. What This Warranty Does Not Cover

This warranty does not cover the following conditions:

- Defects or damage resulting from use of the Product in other than its normal and customary manner.
- Defects or damage from misuse, accident, water, or neglect.
- Defects or damage from improper testing, operation, maintenance, installation, alteration, modification, or adjustment.
- Breakage or damage to antennas unless caused directly by defects in material workmanship.
- A Product subjected to unauthorized Product modifications, disassemblies or repairs (including, without limitation, the addition to the Product of non-Motorola Solutions supplied equipment) which adversely affect performance of the Product or interfere with Motorola Solutions normal warranty inspection and testing of the Product to verify any warranty claim.
- Product which has had the serial number removed or made illegible.
- Rechargeable batteries if:
 - Any of the seals on the battery enclosure or cells are broken or show evidence of tampering.
 - The damage or defect is caused by charging or using the battery in equipment or service other than the Product for which it is specified.
- Freight costs to the repair depot.
- A Product which, due to illegal or unauthorized alteration of the software/firmware in the Product, does not function in accordance with Motorola Solutions published specifications or the FCC type acceptance labeling in effect for the Product at the time the Product was initially distributed from Motorola Solutions.
- Scratches or other cosmetic damage to Product surfaces that does not affect the operation of the Product.
- Normal and customary wear and tear.

VI. Patent And Software Provisions

Motorola Solutions will defend, at its own expense, any suit brought against the end user purchaser to the extent that it is based on a claim that the Product or parts infringe a United States patent, and

Motorola Solutions will pay those costs and damages finally awarded against the end user purchaser in any such suit which are attributable to any such claim.

But such defense and payments are conditioned on the following:

- Motorola Solutions will be notified promptly in writing by such purchaser of any notice of such claim.
- Motorola Solutions will have sole control of the defense of such suit and all negotiations for its settlement or compromise.
- Product or parts become, or in Motorola Solutions opinion be likely to become, the subject of a claim of infringement of a United States patent, that such purchaser will permit Motorola Solutions, at its option and expense, either to procure for such purchaser the right to continue using the Product or parts or to replace or modify the same so that it becomes noninfringing or to grant such purchaser a credit for the Product or parts as depreciated and accept its return. The depreciation will be an equal amount per year over the lifetime of the Product or parts as established by Motorola Solutions.

Motorola Solutions will have no liability with respect to any claim of patent infringement which is based upon the combination of the Product or parts furnished hereunder with software, apparatus or devices not furnished by Motorola Solutions, nor will Motorola Solutions have any liability for the use of ancillary equipment or software not furnished by Motorola Solutions which is attached to or used in connection with the Product. The foregoing states the entire liability of Motorola Solutions with respect to infringement of patents by the Product or any parts thereof.

Laws in the United States and other countries preserve for Motorola Solutions certain exclusive rights for copyrighted Motorola Solutions software such as the exclusive rights to reproduce in copies and distribute copies of such Motorola Solutions software. Motorola Solutions software may be used in only the Product in which the software was originally embodied and such software in such Product may not be replaced, copied, distributed, modified in any way, or used to produce any derivative thereof. No other use including, without limitation, alteration, modification, reproduction, distribution, or reverse engineering of such Motorola Solutions software or exercise of rights in such Motorola Solutions software is permitted. No license is granted by implication, estoppel or otherwise under Motorola Solutions patent rights or copyrights.

VII. Governing Law

This Warranty is governed by the laws of the State of Illinois, USA.

Battery and Charger Warranty

Workmanship Warranty

The workmanship warranty guarantees against defects in workmanship under normal use and service.

All MOTOTRBO Batteries	Two Years
IMPRES Chargers (Single-Unit and Multi-Unit, Non-Display)	Two Years
IMPRES Chargers (Multi-Unit with Display)	One Year
Core Chargers (Single-Unit and Multi-Unit, Non-Display)	Two Years

Capacity Warranty

The capacity warranty guarantees 80% of the rated capacity for the warranty duration.

Nickel Metal-Hydride (NiMH) or Lithium-Ion (Li-Ion) Batteries	12 Months
IMPRES Batteries, when used exclusively with IMPRES Chargers	18 Months

Chapter 1

Introduction

1.1

Radio Description

These portable radios are available in the following frequency ranges and power levels.

Table 1: Radio Frequency Ranges and Power Levels

Frequency Band	Bandwidth	Power Level
VHF	136–174 MHz	1 W or 5 W
UHF	403–512 MHz	1 W or 4 W

These digital radios are among the most sophisticated two-way radios available. They have a robust design for radio users who need high performance, quality, and reliability in their daily communications. This architecture provides the capability of supporting a multitude of legacy and advanced features resulting in a more cost-effective two-way radio communications solution.

1.1.1

Limited Keypad Model

This section explains the name and description of your radio buttons.

Figure 1: Limited Keypad Model



Label	Item	Description
1	Channel Selector Knob	Rotate clockwise to increment channel and counter-clockwise to decrement channel.
2	On/Off/Volume Knob	To turn on the radio, rotate clockwise until the knob clicks; To turn off the radio, rotate counter-clockwise until the knob clicks. Rotate clockwise to increase volume level; rotate counter-clockwise to decrease volume level.
3	LED Indicator	Red, green, and amber light-emitting diodes indicate operating status.
4	Push-To-Talk (PTT)	Press to execute voice operations (for example, Group Call and Private Call).
5	Microphone	Allows the voice to be sent when PTT or voice operations are activated.
6	Side Buttons	These buttons are field programmable using the Customer Programming Software (CPS).

Label	Item	Description
7	Menu Navigation Buttons	Five buttons to provide menu navigation and selection interface.
8	Front Buttons	These buttons are field programmable using the CPS.
9	Liquid Crystal Display (LCD)	65 x132 full dotk-matrix grayscale display provides visual information about many radio features.
10	Speaker	Outputs all tones and audio that are generated by the radio (for example, keypad tones and voice audio).
11	Universal Connector	Interface point for all accessories to be used with the radio. It has eight points to which specific accessories connect and be activated.
12	Antenna	Provides the needed RF amplification when transmitting or receiving.

1.1.2

Non-Keypad Model

This section explains the name and description of your radio buttons.

Figure 2: Non-Keypad Model



Label	Item	Description
1	Channel Selector Knob	Rotate clockwise to increment and counter-clockwise to decrement the channel.
2	On/Off/Volume Knob	To turn on the radio, rotate clockwise until the knob clicks; To turn off the radio, rotate counter-clockwise until the knob clicks. Rotate clockwise to increase volume level; rotate counter-clockwise to decrease volume level.
3	LED Indicator	Red, green, and amber light-emitting diodes indicate operating status.
4	Push-To-Talk (PTT)	Press to execute voice operations (for example, Group Call and Private Call).
5	Microphone	Allows the voice to be sent when PTT or voice operations are activated.
6	Side Buttons	These buttons are field programmable using the Customer Programming Software (CPS).

Label	Item	Description
7	Speaker	Outputs all tones and audio that are generated by the radio (for example, keypad tones and voice audio).
8	Universal Connector	Interface point for all accessories to be used with the radio. It has eight points to which specific accessories connect and be activated.
9	Antenna	Provides the needed RF amplification when transmitting or receiving.

1.2

Portable Radio Model Numbering Scheme

Table 2: Portable Radio Model Numbering Scheme

Position	1	2	3	4	5	6	7	8	9	10	11	12	13
Typical Model Number	AA	H	0	2	J	D	H	9	V	A	2	A	N

Table 3: Sales Models – Description of Symbols

Position	Description	Value
1	Region	AA = North America AZ = Asia LA = Latin America MD = Europe/Middle East/Africa
2	Type of Unit	H = Portable
3	Model Series	23 = XPR 3000 Model Series: 02
4		
5	Band	J = 136–174 MHz R = 403–527 MHz
6	Power Level	C = 1.0, 2.0, 2.5, or 3.5 W D = 4.0–5.0 W
7	Physical Packages	C = Plain Model (Low Tier) H = Monochrome Display Limited Keypad (Mid Tier) T = Non-Keypad (Limited Tier)
8	Channel Information	8 = Variable/Programmable Channel Spacing with unique number of channels 9 = Variable/Programmable Channel Spacing
9	Primary Operation	U = WiFi Only W = Basic (No embedded GOB, Bluetooth, and WiFi)

Position	Description	Value
10	Primary System Type	A = Conventional B = Trunking C = Analog Only
11	Feature Level	1 = Standard with FM 2 = Non-FM 3 = CSA IE CEx ATEX 4 = CQST
12	Version Letter	N/A
13	Unique Variation	N = Standard Package

1.3

Model Charts



NOTICE:

"X" = Part is compatible with checked model.

"_" = The latest version kit. When ordering a kit, refer to your specific kit for the suffix number.

1.3.1

UHF Model Chart

Table 4: XPR 3000e Series, UHF, 403–512 MHz Model Chart

Model/Item			Description
AAH02RDH9V A1AN			XPR 3500e, 403-512 MHz, 4 W, CFS WiFi, MOTOTRBO Limited Keypad Portable
	AAH02RDC9V A1AN		XPR 3300e, 403-512 MHz, 4 W, CFS WiFi, MOTOTRBO Non-Keypad Portable
X		PMLE5107_	Back Cover Kit, CFS WiFi, MOTOTRBO Limited Keypad Portable
	X	PMLE5073_	Back Cover Kit, CFS WiFi, MOTOTRBO Non-Keypad Portable
X		PMLN7294_	Front Cover Kit Limited Keypad
	X	PMLN7272_	Front Cover Kit Non-Keypad
X	X	PMAE4069_	UHF Stubby Antenna 403–450 MHz
X	X	PMAE4070_	UHF Stubby Antenna 440–490 MHz
X	X	PMAE4071_	UHF Stubby Antenna 470–527 MHz
X	X	PMAE4068_	UHF Whip Antenna 403–527 MHz
X	X	PMAE4079_	Slim UHF Whip Antenna 403–527 MHz

1.3.2

VHF Model Chart

Table 5: XPR 3000e Series, VHF, 136–174 MHz Model Chart

Model/Item			Description
AAH02JDH9V A1AN			XPR 3500e, 136–174 MHz, 5 W, CFS WiFi, MOTOTRBO Limited Keypad Portable
	AAH02JDC9V A1AN		XPR 3300e, 136–174 MHz, 5 W, CFS WiFi, MOTOTRBO Non-Keypad Portable
X		PMLD4735_	Back Cover Kit, CFS WiFi, MOTOTRBO Limited Keypad Portable
	X	PMLD4736_	Back Cover Kit, CFS WiFi, MOTOTRBO Non-Keypad Portable
X		PMLN7294_	Front Cover Kit Limited Keypad
	X	PMLN7272_	Front Cover Kit Non-Keypad
X	X	PMAD4117_	VHF Helical Antenna (136–155 MHz)
X	X	PMAD4116_	VHF Helical Antenna (144–165 MHz)
X	X	PMAD4118_	VHF Helical Antenna (152–174 MHz)
X	X	PMAD4119_	VHF Stubby Antenna (136–148 MHz)
X	X	PMAD4120_	VHF Stubby Antenna (146–160 MHz)
X	X	PMAD4121_	VHF Stubby Antenna (160–174 MHz)

1.4

Specifications

Table 6: General Specifications

Parameter	Limited Keypad	Non-Keypad
Channel Capacity	128	16
Frequency	VHF: 136–174 MHz UHF: 403–512 MHz	
Dimensions (H × W × T) with NiMH battery	122.0 x 56.0 x 39.4 mm	122.0 x 56.0 x 39.4 mm
Weight with Core Slim Li-Ion battery	281 g	264 g
Weight with IMPRES Li-Ion battery	281 g	264 g
Weight with Li-Ion IP57 battery	299 g	282 g
Power Supply	7.5 V nominal	
FCC Description	UHF: AZ489FT7068	

Parameter	Limited Keypad	Non-Keypad
	VHF: AZ489FT7069	
IC Description	UHF: 109U-89FT7068 VHF: 109U-89FT7069	
Average battery life at 5/5/90 duty cycle with battery saver enabled in carrier squelch and transmitter in high power.		
Core NiMH IP56 Battery (1400 mAh)	Analog: 9.5 hr	
	Digital: 12.0 hr	
Core Li-Mn Low Temp Submersible Battery (1400 mAh)	Analog: 9.5 hr	
	Digital: 12.0 hr	
IMPRES IP56 Li-Ion Battery (1600 mAh)	Analog: 11.0 hr	
	Digital: 14.5 hr	
Core Slim Li-Ion Battery (1650 mAh)	Analog: 11.5 hr	
	Digital: 15.0 hr	
Slim IMPRES Li-Ion Battery (2050 mAh)	Analog: 14.0 hr	
	Digital: 18.5 hr	
IMPRES Li-Ion Battery (2250 mAh)	Analog: 16.0 hr	
	Digital: 20.5 hr	
IMPRES TIA4950 Hi-Cap Li-Ion Battery (2900 mAh)	Analog: 20.0 hr	
	Digital: 26.5 hr	
IMPRES Ultra Hi-Cap Li-Ion Battery (3000 mAh)	Analog: 21.0 hr	
	Digital: 27.5 hr	
Core Li-Ion IP68 Battery (2450 mAh)	Analog: 17.0 hr	
	Digital: 22.0 hr	
IMPRES Li-Ion IP68 Battery (2450 mAh)	Analog: 17.0 hr	
	Digital: 22.0 hr	

 **NOTICE:**
 Weight can have 5% margin of error.

Table 7: Receiver Specifications

Parameter	Limited Keypad and Non-Keypad
Frequency	VHF: 136–174 MHz UHF: 403–512 MHz
Channel Spacing	12.5 kHz/20 kHz/25 kHz ¹
Frequency Stability (-30 °C to +60 °C)	±0.5 ppm

¹ 25 kHz is NOT available in the USA. FCC narrowbanding rules do not allow operation of this model on 25 kHz configuration in Part 90 VHF/UHF frequencies.

Parameter	Limited Keypad and Non-Keypad
Analog Sensitivity (12 dB SI-NAD)	0.26 μ V (0.15 μ V typical)
Digital Sensitivity (5% BER)	0.22 μ V (0.13 μ V typical)
Intermodulation (TIA603D)	70 dB
Adjacent Channel Selectivity	TIA603A: 60 dB @ 12.5 kHz, 70 dB @ 20/25 kHz TIA603D: 45 dB @ 12.5 kHz, 70 dB @ 20/25 kHz
Spurious Rejection (TIA603D)	70 dB
Rated Audio	500 mW
Audio Distortion @ Rated Audio	5% (3% typical)
Hum and Noise	-40 dB @ 12.5 kHz -45 dB @ 20/25 kHz
Audio Response	TIA603D
Conducted Spurious Emission (TIA603C/D)	-57 dBm

Table 8: Transmitter Specifications

Parameter	Limited Keypad and Non-Keypad
Frequency	VHF: 136–174 MHz UHF: 403–512 MHz
Channel Spacing	12.5/20/25 kHz ²
Frequency Stability (-30 °C to +60 °C)	\pm 0.5 ppm
Power Output (Low Power)	1 W
Power Output (High Power)	VHF: 5 W UHF: 4 W
Modulation Limiting	\pm 2.5 kHz @ 12.5 kHz \pm 5.0 kHz @ 25 kHz ²
FM Hum and Noise	-40 dB @ 12.5 kHz -45 dB @ 25 kHz ²
Conducted/Radiated Emission	-36 dBm < 1 GHz -30 dBm > 1 GHz
Adjacent Channel Power	60 dB @ 12.5 kHz 70 dB @ 25 kHz ²
Audio Response	TIA603D

² 25 kHz is NOT available in the USA. FCC narrowbanding rules do not allow operation of this model on 25 kHz configuration in Part 90 VHF/UHF frequencies.

Parameter	Limited Keypad and Non-Keypad
Audio Distortion	3%
FM Modulation	12.5 kHz: 11K0F3E
	25 kHz: 16K0F3E
4FSK Digital Modulation	12.5kHz Data: 7K60F1D and 7K60FXD
	12.5kHz Voice: 7K60F1E and 7K60FXE
Digital Vocoder Type	AMBE+2™
Digital Protocol	ETSI-TS102361-1
	ETSI-TS102361-2
	ETSI-TS102361-3

Conforms to:

- ETSI TS 102 361 (Parts 1, 2, and 3) - ETSI DMR Standard
- ETSI EN 300 086 - ETSI RF Specifications (Analog)
- ETSI EN 300 113 - ETSI RF Specifications (Digital)
- 1999/5/EC (R&TTE - Radio and Telecommunications Terminal Equipment)
- 2011/65/EU (RoHS 2 - Banned Substances)
- 2012/19/EU (WEEE - Waste Electrical and Electronic Equipment)
- 94/62/EC (Packaging and Packaging Waste)
- Radio meets applicable regulatory requirements.

Table 9: Self-Quieter Frequencies

UHF (MHz)	VHF (MHz)
403.2 +/-10KHz	136.8 +/-10KHz
408 +/-10KHz	139.2 +/-10KHz
410.4 +/-10KHz	144 +/-10KHz
422.4 +/-10KHz	148.8 +/-10KHz
427.2 +/-10KHz	153.6 +/-10KHz
432 +/-10KHz	158.4 +/-10KHz
446.4 +/-10KHz	160 +/-10KHz
456 +/-10KHz	163.2 +/-10KHz
460.8 +/-10KHz	168 +/-10KHz
465.6 +/-10KHz	172.03 +/-10KHz
468 +/-10KHz	172.8 +/-10KHz
480 +/-10KHz	-
499.2 +/-10KHz	-
501.6 +/-10KHz	-
504 +/-10KHz	-
508.8 +/-10KHz	-

UHF (MHz)	VHF (MHz)
519.25 +/-10KHz	-

Table 10: Military Standards

Ap- pli- ca- ble MIL- STD	810C		810D		810E		810F		810G	
	Meth ods	Pro- ce- du- res	Meth ods	Pro- ce- du- res	Meth ods	Pro- ce- du- res	Meth ods	Pro- ce- du- res	Meth ods	Pro- ce- du- res
Low Pres- sure	500.1	I	500.2	II	500.3	II	500.4	II	500.5	II
High Tem- pera- ture	501.1	I , II	501.2	I /A1 , II/A1	501.3	I /A1 , II/A1	501.4	I / Hot, II/H ot	501.5	I /A1 , II/A1
Low Tem- pera- ture	502.1	I	502.2	I /C 3, II/C 1	502.3	I /C 3, II/C 1	502.4	I /C 3, II/C 1	502.5	I /C 3, II/C 1
Tem- pera- ture Shoc k	503.1	I	503.2	A1/C 3	503.3	A1/C 3	503.4	I	503.5	I -C
Solar Ra- di- ation	505.1	II	505.2	I / Hot- Dry	505.3	I / Hot- Dry	505.4	I / Hot- Dry	505.5	I /A1
Rain	506.1	I , II	506.2	I , II	506.3	I , II	506.4	I , III	506.5	I , III
Hu- midi- ty	507.1	II	507.2	II / Hot- Hu- mid	507.3	II / Hot- Hu- mid	507.4	-	507.5	I / Hot- Hu- mid
Salt fog	509.1	I	509.2	I	509.3	I	509.4	-	509.5	-
Dust	510.1	I , II	510.2	I , II	510.3	I , II	510.4	I , II	510.5	I , II
Vi- bra- tion	514.2	VIII/F, Curv e-W, □	514.3	I / Cat1 0, II/ Cat3	514.4	I / Cat1 0, II/ Cat3	514.5	I / Cat2 4, II/ Cat5	514.6	I / Cat2 4, II/ Cat5

Ap- pli- ca- ble MIL- STD	810C		810D		810E		810F		810G	
	Meth ods	Pro- ce- du- res	Meth ods	Pro- ce- du- res	Meth ods	Pro- ce- du- res	Meth ods	Pro- ce- du- res	Meth ods	Pro- ce- du- res
Shoc k	516.2	I , II	516.3	I , IV	516.4	I , IV	516.5	I , IV	516.6	I , IV

Table 11: Environmental Specifications

Parameter	Specifications
Operating Temperature	-30 °C to +60 °C
Storage Temperature	-40 °C to +85 °C
Thermal Shock	Per MIL-STD
Humidity	Per MIL-STD
ESD	IEC 61000-4-2 Level 4
Water Intrusion	IEC 60529 -IP67
Packaging Test	MIL-STD 810D and E

³ Operating temperature specification with Li-Ion battery is -10 °C to +60 °C. Operating temperature specification with NiMH battery is -20 °C to +60 °C.

Chapter 2

Test Equipment and Service Aids

This chapter provides lists of recommended test equipment and service aids, as well as information on field programming equipment that can be used in servicing and programming Motorola Solutions radios.

2.1

Recommended Test Equipment

The list of equipment contained in the following table includes most of the standard test equipment required.

Table 12: Test Equipments

Equipment	Characteristics	Example	Application
Service Monitor	Can be used as a substitute.	Aeroflex 3920 (www.aeroflex.com) or equivalent	Frequency/deviation meter and signal generator for wide-range troubleshooting and alignment.
Digital RMS Multimeter ⁴	100 μ V to 300 V	Fluke 179 (www.fluke.com) or equivalent	AC/DC voltage and current measurements. Audio voltage measurements.
	5 Hz to 1 MHz		
	10 M Ω Impedance		
RF Signal Generator ⁴	100 MHz to 1 GHz	Agilent N5181A (www.agilent.com), Ramsey RSG1000B (www.ramseyelectronics.com), or equivalent	Receiver measurements
	-130 dBm to +10 dBm		
	FM Modulation: 0 kHz to 10 kHz		
	Audio Frequency: 100 Hz to 10 kHz		
Oscilloscope ⁴	2 Channel	Leader LS8050 (www.leader-usa.com), Tektronix TDS1001b (www.tektronix.com) or equivalent	Waveform measurements
	50 MHz Bandwidth		
	5 mV/div to 20 V/div		
Power Meter and Sensor ⁴	5% Accuracy	Bird 43 Thruline Watt Meter (www.bird-electronic.com) or equivalent	Transmitter power output measurements
	100 MHz to 500 MHz		
	50 W		
RF Millivoltmeter	100 mV to 3 V RF	Boonton 92EA (www.boonton.com) or equivalent	RF level measurements
	10 kHz to 1 GHz		

⁴ Can use Service Monitor as substitute.

Equipment	Characteristics	Example	Application
Power Supply	0 V to 32 V	B&K Precision 1790 (www.bkprecision.com) or equivalent	Voltage supply
	0 A to 20 A		

2.2

Service Aids

The following table lists the service aids recommended for working on the radio. While all of these items are available from Motorola Solutions, most are standard workshop equipment items, and any equivalent item capable of the same performance may be substituted for the item listed.

Table 13: Service Aids

Motorola Solutions Part No.	Description	Application
RLN4460_	Portable Test Set	Enables connection to the audio/accessory jack. Allows switching for radio testing.
RVN5115_	CPS on CD-ROM	Allows servicer to program radio parameters, tune and troubleshoot radios.
PMKN4115_	Portable Programming Cable	This cable connects the radio to a USB port for radio programming and data applications.
PMKN4117_	Portable Programming, Testing, and Alignment Cable	This cable connects the radio to a USB port for radio programming, testing, and alignment.  NOTICE: <ul style="list-style-type: none"> This cable does not support external PTT using Testbox. This cable does not auto route to external Audio path once the cable is attached. All test instructions will require through software tool (for example, CPS, Tuner, and more.)
PMNN4428_	7.5 V Universal Battery Eliminator	Connects to radio by using battery eliminator cable.
PMLN6154_	RF Adaptor	Adapts radio antenna port to BC cabling of test equipment.
PMLN6201_	RF Adaptor Holder	Holds RF adaptor in place.
PMLN6422_	SMA RF Cable	RF cable with SMA and N-type connector.
1185937A01	Grease	Acts to lubricate parts.
TL000013A01	Chassis and Knob Opener	Removes chassis from the front housing.
NLN9839_	Vacuum Pump Kit	Allows servicer to test for leakages.
NTN4265_	Pressure Pump Kit	Allows servicer to locate leakages.

Motorola Solutions Part No.	Description	Application
5871134M01	Connector Fitting	This connector allows the vacuum hose to be connected to the radio chassis.
3271133M01	Fitting Seal	This seal secures the connector fitting to the radio chassis.

2.3

Programming, Testing, and Alignment Cable

Programming, Testing, and Alignment Cable and Side Connector are required in servicing and programming radios.

Figure 3: Programming, Testing, and Alignment Cable

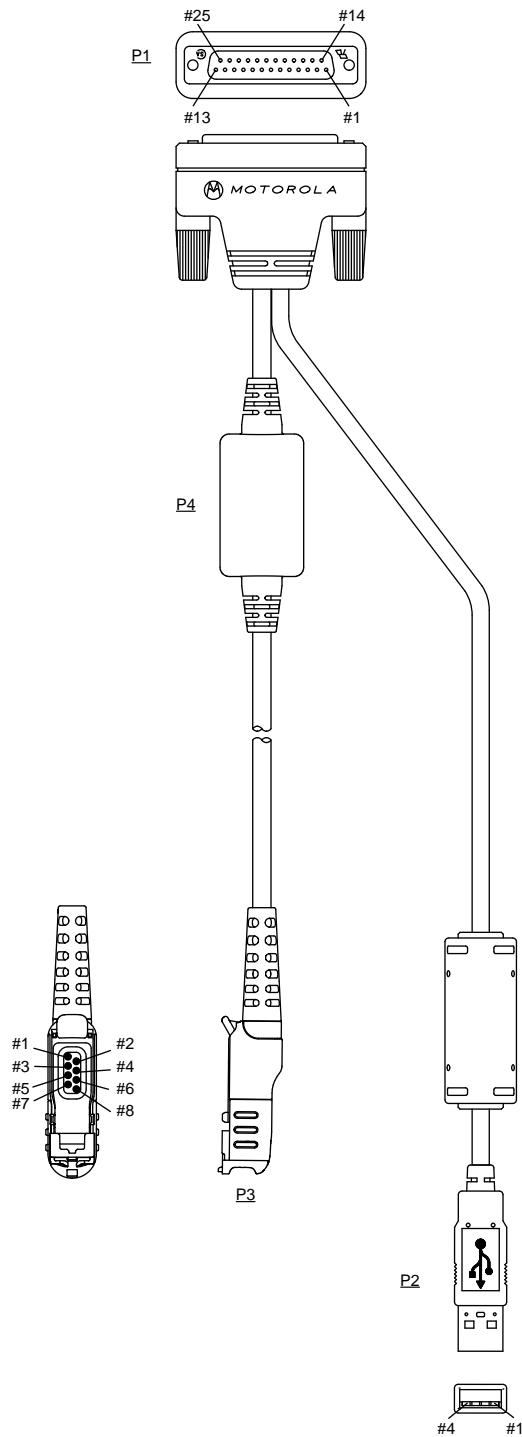
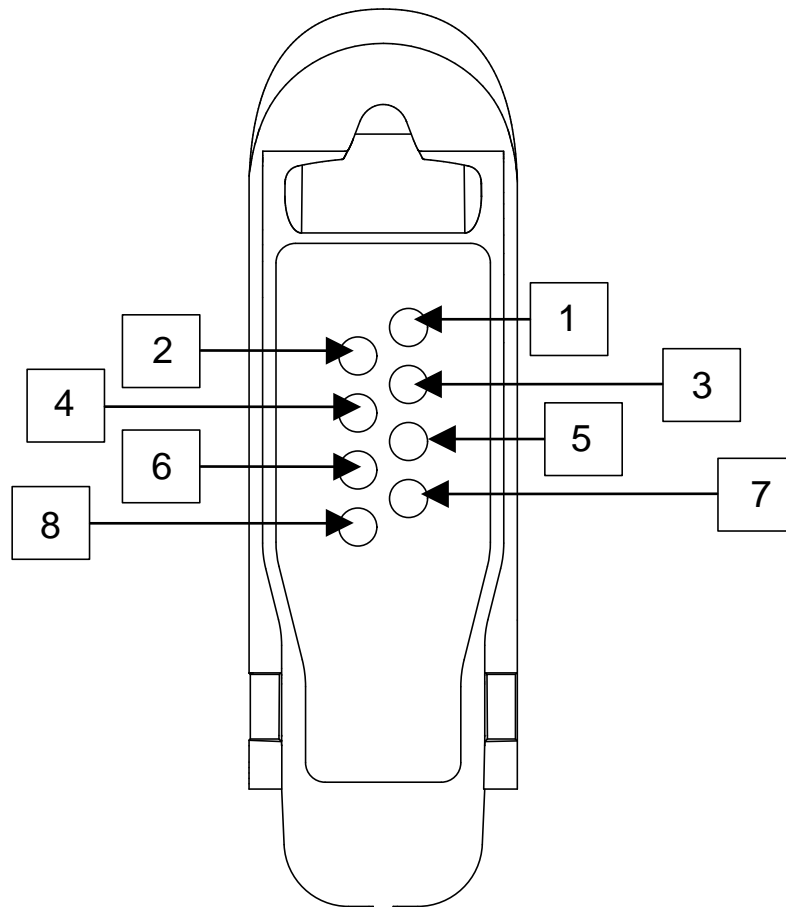

Table 14: Pin Configuration of Side Connector

CONNECTION			
P1	P2	P3	
Pin	Pin	Pin	Function
-	1	1	VCC (5 V)

CONNECTION			
P1	P2	P3	
Pin	Pin	Pin	Function
-	3	5	Data+
-	2	4	Data-
16	4	8	Ground
1 and 5	-	2	External Speaker+
2 and 7	-	3	External Speaker-
17	-	6	External Mic+
16	-	7	External Mic-

Figure 4: Pin Layout of Side Connector



Chapter 3

Transceiver Performance Testing

These radios meet published specifications through their manufacturing process by utilizing high-accuracy laboratory-quality test equipment.

The recommended field service equipment approaches the accuracy of the manufacturing equipment with few exceptions. This accuracy must be maintained in compliance with the calibration schedule recommended by the manufacturer.

Although these radios function in digital and analog modes, all testing is done in analog mode.

3.1 Setup

Supply voltage is provided using a 7.5 VDC power supply. The equipment required for alignment procedures is connected as shown in the Radio Tuning Equipment Setup Diagram.

 **WARNING:** Do NOT use any form of connector, for example wires, crocodile clips, and probes, to supply voltage to the radio, other than the Motorola Solutions approved battery eliminator.

Initial equipment control settings must be as indicated in the following table:

Table 15: Initial Equipment Control Settings

Service Monitor	Power Supply	Test Set
Monitor Mode: Power Monitor	Voltage: 7.5 Vdc	Speaker set: A
RF Attn: -70	DC on/standby: Standby	Speaker/load: Speaker
AM, CW, FM: FM	Volt Range: 10 V	PTT: OFF
Oscilloscope Source: Mod Oscilloscope Horizontal: 10 ms/Div Oscilloscope Vertical: 2.5 kHz/Div Oscilloscope Trigger: Auto Monitor Image: Hi Monitor Bandwidth: Narrow Monitor Squelch: Middle setting Monitor Vol: 1/4 setting	Current: 2.5 A	

3.1.1 Setting Up DMR Transmitter and Receiver Test

Procedure:

- 1 Connect the Programming cable to the radio and computer.
- 2 Remove the RF plug.
- 3 Connect the RF antenna adaptor to the 50 Ω RF Input/Output port of the radio.

- 4 Connect the other end of the RF antenna adaptor to the T/R port of the Radio Test Set 3920 using the RF cable shown in the following figure.

Figure 5: DMR Radio Transmitter and Receiver Testing Setup

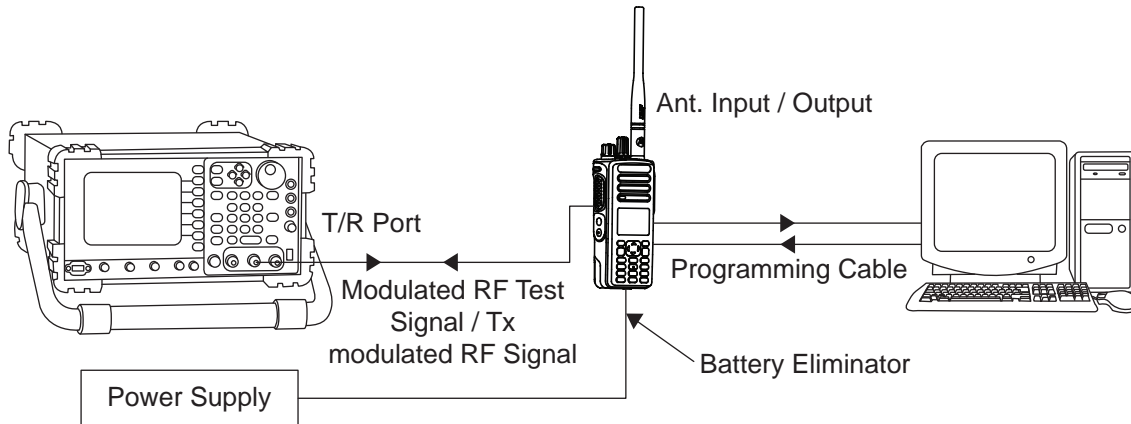

See [RF Plug Disassembly on page 51](#) for RF Plug Removal and RF Adaptor Insertion.

3.2 Display Model Test Mode

3.2.1 Entering Display Radio Test Mode

Procedure:

- 1 Turn the radio on.
- 2 Within 10 seconds after Self-Test is complete, press **Side Button 2** five times in succession.

The radio beeps and shows a series of displays that gives information regarding various version numbers and subscriber-specific information. The displays are described in the following table.

Table 16: Front Panel Access Test Mode Displays

Name of Display	Description	Appears
Service Mode	The literal string indicates the radio has entered test mode.	Always
Host Version	The version of host firmware.	Always
DSP Version	The version of DSP firmware.	Always
Model Number	The radio model number as programmed in the codeplug.	Always
MSN	The radio serial number as programmed in the codeplug.	Always
FLASHCODE	The FLASH codes as programmed in the codeplug.	Always
RF Band	The radio band.	Always



NOTICE: The radio stops at each display for 2 seconds before moving to the next information display. If the information cannot fit into one line, the radio display scrolls automatically character by character after 1 second to view the whole information. If the **Left** button is pressed before the last information display, the radio suspends the information display until the user presses the **Right** button to resume the information display. The radio beeps for each button press. After the last display, `RF Test Mode` is displayed.

3.2.2

RF Test Mode

When the radio is operating in its normal environment, the radio microcontroller controls the RF channel selection, transmitter key-up, and receiver muting, according to the customer codeplug configuration.

However, when the unit is on the bench for testing, alignment, or repair, it must be removed from its normal environment with a special routine, called Test Mode or air test.

3.2.2.1

Testing RF Channel Selections

Prerequisites: In RF Test Mode, the first line of your radio displays `RF Test` and power level icon. And the second line of your radio displays the test environment, channel number, and channel spacing. The default test environment is CSQ.⁵

Procedure:

- 1 Each short press of **Side Button 2** changes the test environment (CSQ->TPL->DIG->USQ->CSQ).



NOTICE: DIG is digital mode and other test environments are analog mode as described in the following table.

Table 17: Test Environments

No. of Beeps	Description	Function
1	Carrier Squelch (CSQ)	RX: if carrier detected TX: mic audio
2	Tone Private-Line (TPL)	RX: unsquelch if carrier and tone detected TX: mic audio + tone
3	Digital Mode (DIG)	RX: if carrier detected TX: mic audio
4	Unsquelch (USQ)	RX: constant unsquelch TX: mic audio

The radio beeps once when radio toggles to CSQ, beeps twice for TPL, beeps three times for DIG, and beeps four times for USQ.

- 2 Each short press of **Side Button 1** toggles the channel spacing between 25 kHz and 12.5 kHz.

⁵ Only for radios with display.

 **NOTICE:** 25 kHz is not available in the USA. FCC narrowbanding rules do not allow operation of this model on 25 kHz configuration in Part 90 VHF/UHF frequencies.

The radio beeps twice for 25 kHz and beeps three times for 12.5 kHz.

- Turn **Channel Knob** to change the test channel from 1 to 14.

See [Table 18: Test Frequencies on page 38](#) for test channel descriptions.

The radio beeps in each position.

Table 18: Test Frequencies

Channel Selector Switch Position	Test Channel	UHF	VHF
1 Low Power	TX#1 or #9	403.15	136.075
9 High Power	RX#1 or #9	403.15	136.075
2 Low Power	TX#2 or #10	423.25	142.575
10 High Power	RX#2 or #10	423.25	142.575
3 Low Power	TX#3 or #11	444.35	146.575
11 High Power	RX#3 or #11	444.35	146.575
4 Low Power	TX#4 or #12	465.45	155.575
12 High Power	RX#4 or #12	465.45	155.575
5 Low Power	TX#5 or #13	485.55	161.575
13 High Power	RX#5 or #13	485.55	161.575
6 Low Power	TX#6 or #14	506.65	167.575
14 High Power	RX#6 or #14	506.65	167.575
7 Low Power	TX#7 or #15	526.75	173.975
15 High Power	RX#7 or #15	526.75	173.975
8 Low Power	TX#8 or #16	527.00	174.000
16 High Power	RX#8 or #16	527.00	174.000

Table 19: Transmitter Performance Checks

Test Name	Communications Analyzer	Radio	Test Set	Comments
Reference Frequency	Mode: PWR MON Fourth channel test frequency ⁶ Monitor: Frequency error Input at RF In/Out	Test Mode, Test Channel 4 carrier squelch	PTT to continuously transmit.	Frequency error to be: ±68 Hz for VHF ±201 Hz for UHF
Power RF	As above	As above	As above	Low Power:

⁶ See [Table 18: Test Frequencies on page 38](#).

Test Name	Communications Analyzer	Radio	Test Set	Comments
				0.9–1.5 W (UHF/VHF) High Power: 4.0–4.8 W (UHF) 5.0–6.0 W (VHF)
Voice Modulation	Mode: PWR MON Fourth channel test frequency ⁶ atten to -70, input to RF In/Out Monitor: DVM: AC Volts Set 1 kHz Mod Out level for 0.025 Vrms at test set, 80 mVrms at AC/DC test set jack	As above	As above, meter selector to mic	Deviation: ≥ 4.0 kHz but ≤ 5.0 kHz (25 kHz Ch Sp).
Internal Voice Modulation	Mode: PWR MON Fourth channel test frequency ⁶ atten to -70, input to RF In/Out	Test Mode, Test Channel 4 carrier squelch output at antenna	Remove modulation input	Press PTT switch on radio. Say "four" loudly into the radio mic. Measure deviation: ≥ 4.0 kHz but ≤ 5.0 kHz (25 kHz Ch Sp)
TPL Modulation	As above Fourth channel test frequency ⁶ BW to narrow	Test Mode, Test Channel 4 TPL	As above	Deviation: ≥500 Hz but ≤1000Hz (25 kHz Ch Sp).



NOTICE: 25 kHz is not available in the USA. FCC narrowbanding rules do not allow operation of this model on 25 kHz configuration in Part 90 VHF/UHF frequencies.

Table 20: Receiver Performance Checks

Test Name	Communications Analyzer	Radio	Test Set	Comments
Reference Frequency	Mode: PWR MON Fourth channel test frequency ⁶ Monitor: Frequency error Input at RF In/Out	Test Mode, Test Channel 4 carrier squelch output at antenna.	PTT to continuously transmit.	Frequency error to be: ±68 Hz for VHF ±201 Hz for UHF

Test Name	Communications Analyzer	Radio	Test Set	Comments
Rated Audio	Mode: GEN Output level: 1.0 mV RF Sixth channel test frequency ⁶ Mod: 1 kHz tone at 3 kHz deviation Monitor: DVM: AC Volts	Test Mode , Test Channel 6 carrier squelch	Meter selector to Audio PA	Set volume control to 2.83 Vrms
Distortion	As above, except distortion	As above	As above	Distortion <3.0%
Sensitivity (SINAD)	As above, except SINAD, lower the RF level for 12 dB SINAD.	As above	Nil	RF input to be <0.35 μ V
Noise Squelch Threshold (only radios with conventional system need to be tested.)	RF level set to 1 mV RF	As above	Meter selection to Audio PA, speaker/load to speaker	Set volume control to 2.83 Vrms
	As above, except change frequency to a conventional system. Raise RF level from zero until radio unsquelches.	Out of Test Mode; select a conventional system.	As above	Unsquelch to occur at <0.25 μ V. Preferred SINAD = 6–8 dB

3.2.3

Display Test Mode

Procedure:

- 1 Press and hold **Side Button 1** to enter display test mode.
- 2 Upon any button or key press, the LCD displays the growing horizontal bars. Press any button until the LCD display turns black and change to vertical bars. Press any button until LCD display full screen black and change to icon display.

The LCD displays the following icons:

- RSSI (with full bar)
- Monitor
- Tone disabled
- Priority-two channel scan
- Unread message
- Emergency

- Talkaround
- Battery strength indicator (with full bar)

The LCD display become clear and consequently display the rest of the icons, high-power level icon (H), companding icon, option board icon, and secure operation icon upon any button/key press.

3.2.4

LED Test Mode

Procedure:

- 1 Press and hold **Side Button 1** after Display Test Mode.
The radio beeps once and displays `LED Test Mode`.
- 2 Press any button/key.
The red LED lights up and the radio displays `Red LED On`.
- 3 Press any button/key.
The red LED is turned off. The green LED lights up and the radio displays `Green LED On`.
- 4 Press any button/key.
The green LED is turned off. The radio lights up both LEDs up while displaying `Both LEDs On`.
The orange LED lights up.

3.2.5

Backlight Test Mode

Procedure:

- Press and hold **Side Button 1** after LED Test Mode.
The radio beeps once and displays `Backlight Test Mode`.

The radio turns on both LCD and keypad backlight together.

3.2.6

Speaker Tone Test Mode

Procedure:

- Press and hold **Side Button 1** after Backlight Test Mode.
The radio beeps once and displays `Speaker Tone Test Mode`.

The radio generates a 1 kHz tone with the internal speaker.

3.2.7

Earpiece Tone Test Mode

Procedure:

- 1 Connect the external accessory to the radio.

- 2 Press and hold **Side Button 1** after Speaker Tone Test Mode.

The radio beeps once and displays `Earpiece Tone Test Mode`.

The radio generates a 1 kHz tone from the earpiece.

3.2.8

Audio Loopback Earpiece Test Mode

Procedure:

Press and hold **Side Button 1** after the Audio Loopback Test Mode.

The radio beeps once and displays `Audio Loopback Earpiece Test Mode`.

The radio routes any audio on the external mic to the earpiece.

3.2.9

Battery Check Test Mode

Procedure:

Press and hold **Side Button 1** after Audio Loopback Earpiece Test Mode.

The radio beeps once and momentarily displays `Battery Check Test Mode`.

The radio displays the following:

Figure 6: Battery Check Test Mode Display

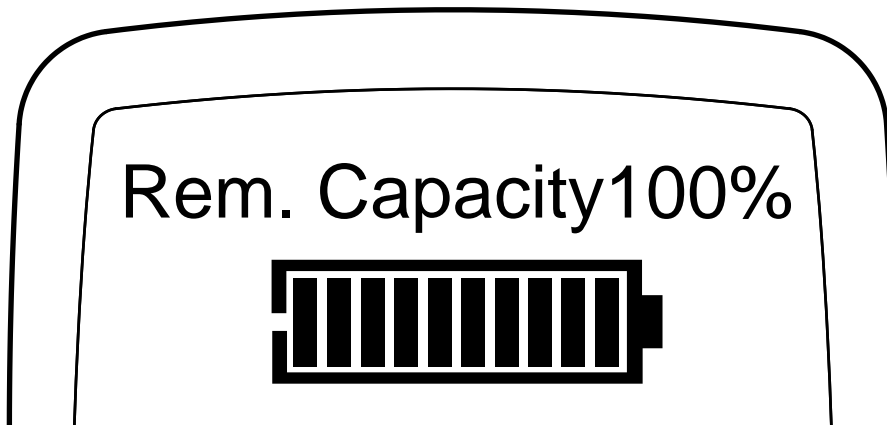

3.2.10

Button/Knob/PTT Test Mode

Any key press causes the test to advance from one step to the next.

Table 21: Button/Knob/PTT Checks

Action	Result
Press and hold Side Button 1 .	The radio displays <code>Button Test (line 1)</code> . The radio beeps once.
Rotate the Volume Knob .	<code>2/1</code> through <code>2/255</code> appears.

Action	Result
	The radio beeps at each position.
Rotate the Channel Knob clockwise.	4/1 appears. The radio beeps at each position.
Rotate the Channel Knob counterclockwise.	4/-1 appears. The radio beeps at each position.
Press Side Button 1 .	96/1 appears. The radio beeps.
Release the button.	96/0 appears. The radio beeps.
Press Side Button 2 .	97/1 appears. The radio beeps.
Release the button.	97/0 appears. The radio beeps.
Press the PTT button.	1/1 appears. The radio beeps.
Release the button.	1/0 appears. The radio beeps.

Table 22: Keypad Checks

Action	Result
Press the P1 button.	160/1 appears. The radio beeps.
Release the button.	160/0 appears. The radio beeps.
Press the P2 button.	161/1 appears. The radio beeps.
Release the button.	161/0 appears. The radio beeps.
Press the MENU button.	85/1 appears. The radio beeps.
Release the button.	139/0 appears. The radio beeps.
Press the BACK button.	129/1 appears. The radio beeps.
Release the button.	129/0 appears. The radio beeps.
Press the Left button.	128/1 appears. The radio beeps.

Action	Result
Release the button.	128/0 appears. The radio beeps.
Press the Right button.	130/1 appears. The radio beeps.
Release the button.	130/0 appears. The radio beeps.
Press the OK button.	85/1 appears. The radio beeps.
Release the button.	85/0 appears. The radio beeps.

3.3 Non-Display Model Test Mode

3.3.1 Entering Non-Display Radio Test Mode

Procedure:

- 1 Turn the radio on.
- 2 Within 10 seconds after Self-Test is complete, press **Side Button 2** five times in succession.

The radio beeps.

3.3.2 RF Test Mode

When the radio is operating in its normal environment, the radio microcontroller controls the RF channel selection, transmitter key-up, and receiver muting, according to the customer codeplug configuration.

However, when the unit is on the bench for testing, alignment, or repair, it must be removed from its normal environment with a special routine, called Test Mode or air test.

3.3.2.1 Testing RF Channel Selections

Prerequisites: In RF Test Mode, the first line of your radio displays `RF Test` and power level icon. And the second line of your radio displays the test environment, channel number, and channel spacing. The default test environment is CSQ.⁷

Procedure:

- 1 Each short press of **Side Button 2** changes the test environment (CSQ->TPL->DIG->USQ->CSQ).

⁷ Only for radios with display.



NOTICE: DIG is digital mode and other test environments are analog mode as described in the following table.

Table 23: Test Environments

No. of Beeps	Description	Function
1	Carrier Squelch (CSQ)	RX: if carrier detected TX: mic audio
2	Tone Private-Line (TPL)	RX: unsquelch if carrier and tone detected TX: mic audio + tone
3	Digital Mode (DIG)	RX: if carrier detected TX: mic audio
4	Unsquelch (USQ)	RX: constant unsquelch TX: mic audio

The radio beeps once when radio toggles to CSQ, beeps twice for TPL, beeps three times for DIG, and beeps four times for USQ.

- Each short press of **Side Button 1** toggles the channel spacing between 25 kHz and 12.5 kHz.



NOTICE: 25 kHz is not available in the USA. FCC narrowbanding rules do not allow operation of this model on 25 kHz configuration in Part 90 VHF/UHF frequencies.

The radio beeps twice for 25 kHz and beeps three times for 12.5 kHz.

- Turn **Channel Knob** to change the test channel from 1 to 14.

See [Table 24: Test Frequencies on page 45](#) for test channel descriptions.

The radio beeps in each position.

Table 24: Test Frequencies

Channel Selector Switch Position	Test Channel	UHF	VHF
1 Low Power	TX#1 or #9	403.15	136.075
9 High Power	RX#1 or #9	403.15	136.075
2 Low Power	TX#2 or #10	423.25	142.575
10 High Power	RX#2 or #10	423.25	142.575
3 Low Power	TX#3 or #11	444.35	146.575
11 High Power	RX#3 or #11	444.35	146.575
4 Low Power	TX#4 or #12	465.45	155.575
12 High Power	RX#4 or #12	465.45	155.575
5 Low Power	TX#5 or #13	485.55	161.575
13 High Power	RX#5 or #13	485.55	161.575
6 Low Power	TX#6 or #14	506.65	167.575

Channel Selector Switch Position	Test Channel	UHF	VHF
14 High Power	RX#6 or #14	506.65	167.575
7 Low Power	TX#7 or #15	526.75	173.975
15 High Power	RX#7 or #15	526.75	173.975
8 Low Power	TX#8 or #16	527.00	174.000
16 High Power	RX#8 or #16	527.00	174.000

Table 25: Transmitter Performance Checks

Test Name	Communications Analyzer	Radio	Test Set	Comments
Reference Frequency	Mode: PWR MON Fourth channel test frequency ⁸ Monitor: Frequency error Input at RF In/Out	Test Mode, Test Channel 4 carrier squelch	PTT to continuously transmit.	Frequency error to be: ±68 Hz for VHF ±201 Hz for UHF
Power RF	As above	As above	As above	Low Power: 0.9–1.5 W (UHF/VHF) High Power: 4.0–4.8 W (UHF) 5.0–6.0 W (VHF)
Voice Modulation	Mode: PWR MON Fourth channel test frequency ⁸ atten to -70, input to RF In/Out Monitor: DVM: AC Volts Set 1 kHz Mod Out level for 0.025 Vrms at test set, 80 mVrms at AC/DC test set jack	As above	As above, meter selector to mic	Deviation: ≥ 4.0 kHz but ≤ 5.0 kHz (25 kHz Ch Sp).
Internal Voice Modulation	Mode: PWR MON Fourth channel test frequency ⁸ atten to -70, input to RF In/Out	Test Mode, Test Channel 4 carrier squelch output at antenna	Remove modulation input	Press PTT switch on radio. Say "four" loudly into the radio mic. Measure deviation: ≥ 4.0 kHz but ≤ 5.0 kHz (25 kHz Ch Sp)

⁸ See Table 24: Test Frequencies on page 45.

Test Name	Communications Analyzer	Radio	Test Set	Comments
TPL Modulation	As above Fourth channel test frequency ⁸ BW to narrow	Test Mode, Test Channel 4 TPL	As above	Deviation: ≥500 Hz but ≤1000Hz (25 kHz Ch Sp).



NOTICE: 25 kHz is not available in the USA. FCC narrowbanding rules do not allow operation of this model on 25 kHz configuration in Part 90 VHF/UHF frequencies.

Table 26: Receiver Performance Checks

Test Name	Communications Analyzer	Radio	Test Set	Comments
Reference Frequency	Mode: PWR MON Fourth channel test frequency ⁸ Monitor: Frequency error Input at RF In/Out	Test Mode, Test Channel 4 carrier squelch output at antenna.	PTT to continuously transmit.	Frequency error to be: ±68 Hz for VHF ±201 Hz for UHF
Rated Audio	Mode: GEN Output level: 1.0 mV RF Sixth channel test frequency ⁸ Mod: 1 kHz tone at 3 kHz deviation Monitor: DVM: AC Volts	Test Mode, Test Channel 6 carrier squelch	Meter selector to Audio PA	Set volume control to 2.83 Vrms
Distortion	As above, except distortion	As above	As above	Distortion <3.0%
Sensitivity (SINAD)	As above, except SINAD, lower the RF level for 12 dB SINAD.	As above	Nil	RF input to be <0.35 μV
Noise Squelch Threshold (only radios with conventional system need to be tested.)	RF level set to 1 mV RF	As above	Meter selection to Audio PA, speaker/load to speaker	Set volume control to 2.83 Vrms
	As above, except change frequency to a conventional system. Raise RF level from zero until radio un-squelches.	Out of Test Mode; select a conventional	As above	Unsquench to occur at <0.25 μV. Preferred SINAD = 6–8 dB

Test Name	Communications Analyzer	Radio	Test Set	Comments
				tional system.

3.3.3

LED Test Mode

Procedure:

- 1 Press and hold **Side Button 1** after RF Test Mode.

The radio beeps once.

- 2 Press any button/key.
The red LED lights up.

- 3 Press any button/key.
The red LED turns off and the radio lights up the green LED.

- 4 Press any button/key.

The green LED turns off and the radio turns on both LEDs.

3.3.4

Speaker Tone Test Mode

Procedure:

Press and hold **Side Button 1** after LED Test Mode.

The radio beeps once.

The radio generates a 1 kHz tone with the internal speaker.

3.3.5

Earpiece Tone Test Mode

Procedure:

Press and hold **Side Button 1** after Speaker Tone Test Mode.

The radio beeps once.

The radio generates a 1 kHz tone with the earpiece.

3.3.6 Audio Loopback Earpiece Test Mode

Procedure:

Press and hold **Side Button 1** after Audio Loopback Test Mode.

The radio beeps once.

The radio routes any audio on the external mic to the earpiece.

3.3.7 Battery Check Test Mode

Procedure:

Press and hold **Side Button 1** after Audio Loopback Earpiece Test Mode.

The radio beeps once.

The radio LED lights up as follows:

- Green LED for High Battery Level
- Orange LED for Mid Battery Level
- Blinking red LED for Low Battery Level

3.3.8 Button/Knob/PTT Test Mode

Any key press causes the test to advance from one step to the next.

Table 27: Button/Knob/PTT Checks

Action	Result
Press and hold Side Button 1 .	The radio beeps once.
Rotate the Volume Knob .	The radio beeps at each position.
Rotate the Channel Knob .	The radio beeps at each position.
Press Side Button 1 .	The radio beeps.
Release the button.	The radio beeps.
Press Side Button 2 .	The radio beeps.
Release the button.	The radio beeps.
Press the PTT button.	The radio beeps.
Release the button.	The radio beeps.

Chapter 4

Radio Programming and Tuning

This chapter provides an overview of the MOTOTRBO Customer Programming Software (CPS), Tuner, and AirTracer applications, which are all designed for use in a Windows 8/7/2000/XP/Vista environment.



NOTICE:

Refer to the appropriate program online help files for the programming procedures.

These programs are available in one kit as listed in the following table. An Installation Guide is also included with the kit.

Table 28: Software Installation Kits Radio Tuning Setup

Description	Part Number
MOTOTRBO CPS, Tuner, and AirTracer Applications CD	RVN5115_

4.1

Customer Programming Software Setup

The CPS programming setup shown is used to program the radio.



CAUTION: Computer USB ports can be sensitive to Electrostatic Discharge. Do not touch exposed contacts on cable when connected to a computer.



NOTICE: Refer to appropriate program online help files for the programming procedures.

Figure 7: CPS Programming Setup

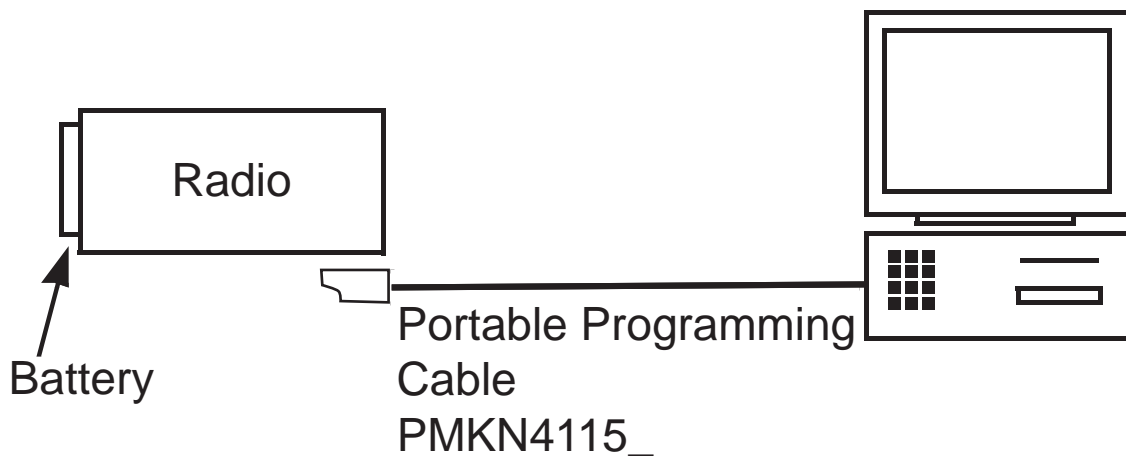

4.2

AirTracer Application Tool

The MOTOTRBO AirTracer application tool has the ability to capture over-the-air digital radio traffic and save the captured data into a file.

The AirTracer application tool can also retrieve and save internal error logs from MOTOTRBO radios. The saved files can be analyzed by trained Motorola Solutions personnel to suggest improvements in system configurations or to help isolate problems.

4.3

Radio Tuning Setup

Retuning is not required if service kit has been replaced and factory tuned. However, check service kit for performance before use.

Before keying up the radio, set the Bias DAC for the appropriate final device bias current prior to keying up the radio. If the bias is not properly set, it may cause damage to the transmitter.



CAUTION: Only Motorola Solutions Service Centers or Authorized Motorola Solutions Service Dealers can perform this function.

A personal computer (PC) with Windows, Windows 2000/XP/Vista/Windows 7 and a tuner program are required to tune the radio. See [Figure 8: Radio Tuning Equipment Setup on page 51](#) to perform tuning procedures.

Figure 8: Radio Tuning Equipment Setup

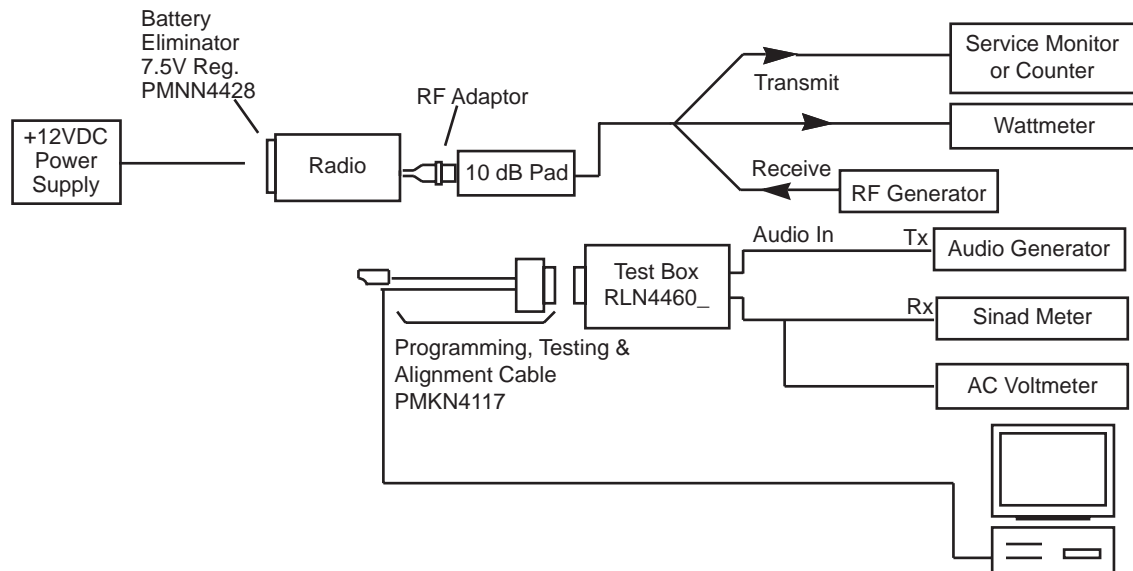

NOTICE: Refer to appropriate program online help files for the programming procedures.

4.3.1

RF Plug Disassembly

Procedure:

- 1 Use tweezers to lift up one end of the RF plug and pull it out.

Figure 9: RF Plug disassembly



Label	Description
1	RF Plug

- 2 Insert the RF Adaptor into the front housing.

Figure 10: RF Adaptor insertion



Label	Description
1	RF Adaptor

- 3 Screw in the RF adaptor to the front housing.

Figure 11: RF Adaptor screw



- 4 Insert the RF connector.



CAUTION: Do not attach the RF Connector into the RF Adapter Holder before inserting the RF Adapter Holder into the housing.

Figure 12: RF Connector



Chapter 5

Disassembly/Reassembly Procedures

This chapter provides details about the following:

- Preventive maintenance (inspection and cleaning).
- Safe handling of CMOS and LDMOS devices.
- Repair procedures and techniques.
- Disassembly and reassembly of the radio.

5.1

Preventive Maintenance

Periodic visual inspection and cleaning are recommended.

Inspection

Check that the external surfaces of your radio are clean, and that all external controls and switches are functional. It is not recommended to inspect the interior electronic circuitry.

Cleaning Procedures

The following procedures describe the recommended cleaning agents and the methods to clean the external and internal surfaces of your radio.

External surfaces include the front cover, housing assembly, and battery case. These surfaces should be cleaned whenever a periodic visual inspection reveals the presence of smudges, grease, and/or grime.



CAUTION: Use all chemicals as prescribed by the manufacturer. Follow all safety precautions as defined on the label or material safety data sheet.

The effects of certain chemicals and their vapors can have harmful results on certain plastics. Avoid using aerosol sprays, tuner cleaners, and other chemicals.



NOTICE: Only clean internal surfaces when your radio is disassembled for service or repair.

Cleaning External Plastic Surfaces



IMPORTANT: The only recommended agent for cleaning the external radio surfaces is a 0.5% solution of a mild dish-washing detergent in water.

Apply the 0.5% detergent-water solution sparingly with a stiff, non-metallic, short-bristled brush to work all loose dirt away from your radio. Use a soft, absorbent, lint-less cloth, or tissue to remove the solution and dry your radio. Make sure that no water remains entrapped near the connectors, cracks, or crevices.

Cleaning Internal Circuit Boards and Components



IMPORTANT:

The only factory recommended liquid for cleaning the printed circuit boards and their components is isopropyl alcohol (100% by volume).

Always use fresh supply of alcohol and a clean container to prevent contamination by dissolved material (from previous usage).

Apply Isopropyl alcohol (100%) with a stiff, non-metallic, short-bristled brush to dislodge embedded or caked materials located in hard-to-reach areas. The brush stroke should direct the dislodged material out and away from the inside of your radio. Make sure that controls or tunable components are not soaked with alcohol. Do not use high-pressure air to hasten the drying process since it can cause the liquid to collect in unwanted places. After completing of the cleaning process, use a soft, absorbent, lint-less cloth to dry the area. Do not brush or apply any isopropyl alcohol to the frame, front cover, or back cover.

5.2

Safe Handling of CMOS and LDMOS Devices

Complementary Metal Oxide Semiconductor (CMOS) and Laterally Diffused Metal Oxide Semiconductor (LDMOS) devices are used in this family of radios, and are susceptible to damage by electrostatic or high-voltage charges.

Damage can be latent, resulting in failures occurring weeks or months later. Therefore, special precautions must be taken to prevent device damage during disassembly, troubleshooting, and repair.

Handling precautions are mandatory for CMOS/LDMOS circuits and are especially important in low humidity conditions. Do not attempt to disassemble your radio without referring to the following caution statement.



CAUTION:

This radio contains static-sensitive devices. Do not open your radio unless you are properly grounded. Take the following precautions when working on this unit:

- Store and transport all CMOS/LDMOS devices in conductive material so that all exposed leads are shorted together. Do not insert CMOS/LDMOS devices into conventional plastic "snow" trays used for storage and transportation of other semiconductor devices.
- Ground the working surface of the service bench to protect the CMOS/LDMOS device. It is recommended that you use a wrist strap, two ground cords, a table mat, a floor mat, electrostatic discharge (ESD) shoes, and an ESD chair.
- Wear a conductive wrist strap in series with a 100k resistor to ground. Replacement wrist straps that connect to the bench top covering are Motorola Solutions part number 4280385A59.
- Do not wear nylon clothing while handling CMOS/LDMOS devices.
- Do not insert or remove CMOS/LDMOS devices with power applied. Check all power supplies used for testing CMOS/LDMOS devices to be certain that there are no voltage transients present.
- When straightening CMOS/LDMOS pins, provide ground straps for the apparatus used.
- When soldering, use a grounded soldering iron.
- Handle CMOS/LDMOS devices by the package and not by the leads. Before touching the unit, touch an electrical ground to remove any static charge that you may have accumulated. The package and substrate may be electrically common. If so, the reaction of a discharge to the case would cause the same damage as touching the leads.

5.3

General Repair Procedures and Techniques

Environmentally Preferred Products (EPP) were developed and assembled using environmentally preferred components and solder assembly techniques to comply with the European Union's Restriction of Hazardous Substances (ROHS 2) Directive 2011/65/EU and Waste Electrical and Electronic Equipment (WEEE) Directive 2012/19/EU. To maintain product compliance and reliability, use only the Motorola Solutions specified parts in this manual.

For the identification of lead (Pb) free assemblies, all EPP products carry the EPP Marking, shown in the following examples, on the Printed Circuit Board (PCB). This marking provides information to those performing assembly, servicing, and recycling operation on this product, adhering to the JEDEC Standard No. 97. The EPP Marking takes the form of a label or marking on the PCB.

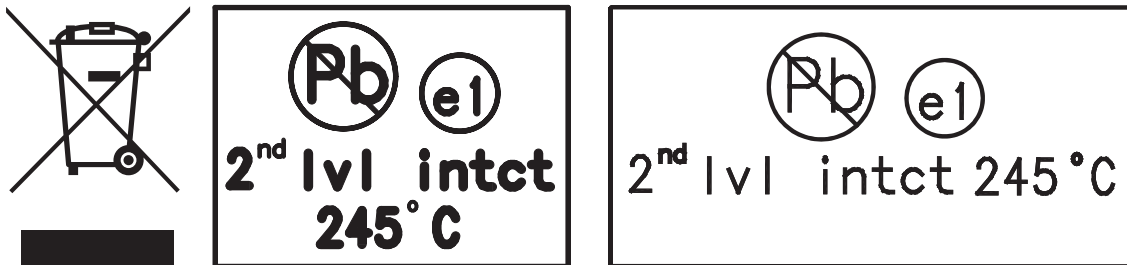

Any rework or repair on Environmentally Preferred Products must be done using the appropriate lead-free solder wire and lead-free solder paste as stated in the following tables:

Table 29: Lead Free Solder Wire Part Number List

Motorola Solutions Part Number	Alloy	Flux Type	Flux Content by Weight	Melting Point	Supplier Part number	Diameter	Weight
1088929Y01	95.5Sn/3.8Ag/0.7Cu	RMA Version	2.7–3.2%	217 °C	52171	0.015 in.	1 lb spool

Table 30: Lead Free Solder Paste Part Number List

Motorola Solutions Part Number	Manufacturer Part Number	Viscosity	Type	Composition and Percent Metal	Liquid Temperature
1085674C03	NC-SMQ230	900–1000KCPs Brookfield (5 rpm)	Type 3 (-325/+500)	(95.5%Sn-3.8%Ag-0.7%Cu) 89.3%	217 °C

Parts Replacement and Substitution

When damaged parts are replaced, identical parts must be used. If the identical replacement part is not locally available, check the parts list for the proper Motorola Solutions part number and order the part.

Rigid Circuit Boards

This family of radios use bonded, multi-layer, printed circuit boards. Since the inner layers are not accessible, some special considerations are required when soldering and unsoldering components. The plated-through holes may interconnect multiple layers of the printed circuit. Therefore, exercise care to avoid pulling the plated circuit out of the hole.

When soldering near a connector:

- Avoid accidentally getting solder in the connector.
- Be careful not to form solder bridges between the connector pins.
- Examine your work closely for shorts due to solder bridges.

For soldering components with Hot-Air or infra red solder systems, check the user guide of your solder system to get information on solder temperature and time for the different housings of the integrated circuits and other components.

5.4

Disassembling and Reassembling the Radio

When disassembling and reassembling the radio, it is important to pay particular attention to the snaps and tabs, and how parts align with each other.



CAUTION: To assure the safety and regulatory compliance of your radio, repair your radio only at Motorola Solutions service facilities. Please contact your local dealer or Point of Sale for further instructions.

The following tools are required for disassembling the radio:

- TORX™ T screwdriver
- Chassis and Knob Opener (TL000013A01)

The following tools are required for reassembling the radio:

- Grease (1185937A01)
- TORX T screwdriver
- Vacuum Pump Kit (NLN9839) - Radio Immersibility Test
- Pressure Pump Kit (NTN4265) - Radio Immersibility Test
- Connector Fitting (5871134M01) - Radio Immersibility Test
- Fitting Seal (3271133M01) - Radio Immersibility Test
- Seal Port (3286058L01)
- Ventilation Label (LB000256A01)



NOTICE: If a unit requires further testing or service than is customarily performed at the basic level, send radio to Motorola Solutions Service Center.

5.5

Torque Chart

Torque Chart lists the various screws by part number and description, followed by the torque values in different units of measure.



NOTICE: Torque all screws to the recommended value when assembling the radio.

Table 31: Torque Specifications for Screws

Part Number	Description	Driver/Socket	Torque	
			lbs-in	N-m
0385273D06	K18 Screw (Speaker Retainer)	T6 Torx	2.0 to 2.2	0.23 to 0.25

Part Number	Description	Driver/Socket	Torque	
			lbs-in	N-m
	K18 Screw (Key-pad-Display Retainer)	T6 Torx	1.5 to 1.7	0.17 to 0.19
03012034001	M2 Screw (Main-board Assembly) - New Chassis	T6 Torx	3.1 to 3.5	0.35 to 0.40
	M2 Screw (Main-board Assembly) - Rework Chassis	T6 Torx	2.0	0.23
0316281H01	Front Kit-Back Kit Screw	T6 Torx	2.1 to 2.3	0.24 to 0.26

5.6

Detailed Radio Disassembly

The following content describes the detailed disassembly procedure of your radio.

5.6.1

Front Kit from Chassis Disassembly

Procedure:

- 1 Turn off the radio.
- 2 Remove the battery:
 - a Release the battery latch by moving it into the unlock position.

Figure 13: Battery removal



Label	Description
1	Latch

- b** With the latch released, slide the battery downwards.

Figure 14: Battery removal



- 3** Remove the battery from the radio.
- 4** Remove the antenna by turning it counterclockwise.

Figure 15: Antenna removal



- 5 Remove the volume and channel knobs off from their shafts using the knob removal tool.

Figure 16: Volume and Channel Knob removal.



Label	Description
1	Volume Knob
2	Channel Knob

 **NOTICE:** Both knobs slide on and off. However, they are supposed to fit very tightly on their shafts.

- 6 Separate the back kit from the front kit as follows:
 - a Unscrew the screw using TORX T6 screwdriver.

Figure 17: Front Kit-Back Kit Screw removal



- b** Use the chassis and knob opener to separate the back kit from the front kit.

Figure 18: Back Kit disassembly



- c** Slowly slide out the back kit from the front kit.

Figure 19: Back Kit removal



CAUTION:

Do not force the chassis out if it gets stuck by pulling it. This will cause damage to the front kit.

Do not pull out the chassis forcefully as this will cause damage to the flex connector.

- 7 Lay the front kit down. Rotate the back kit backward and slightly away from the front kit.
- 8 Lift the Zero Insertion Force (ZIF) connector latch on the mainboard assembly to release the flex and separate the back kit from the front kit.

Figure 20: Disconnecting the interface UC-audio flex and keypad-display flex (Limited Keypad Model)

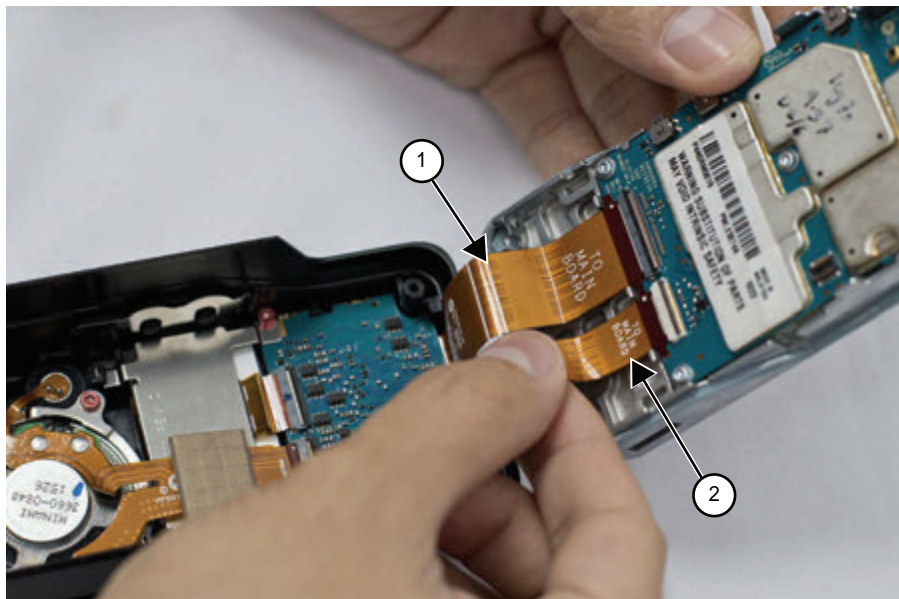

Label	Description
1	Interface Keypad-Display Flex

Label	Description
2	Interface UC-Audio Flex

Figure 21: Disconnecting the UC-audio flex (Non-Keypad Model)

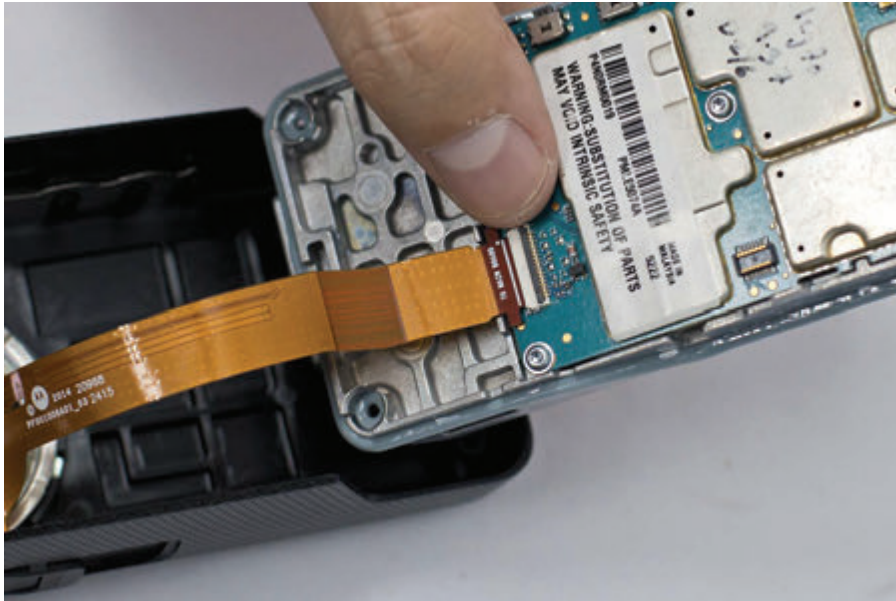

5.6.2

Back Kit Disassembly

Procedure:

- 1 Remove the top control seal.

Figure 22: Top control seal removal

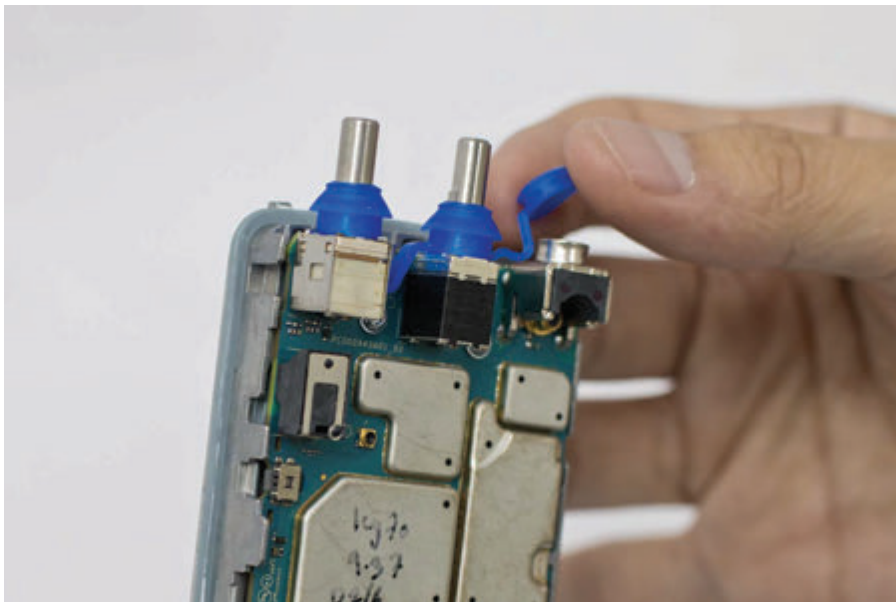

- 2 Use a TORX screwdriver with a T6 head to remove the five M2 screws holding the mainboard assembly to the back kit.

Figure 23: Back Kit disassembly

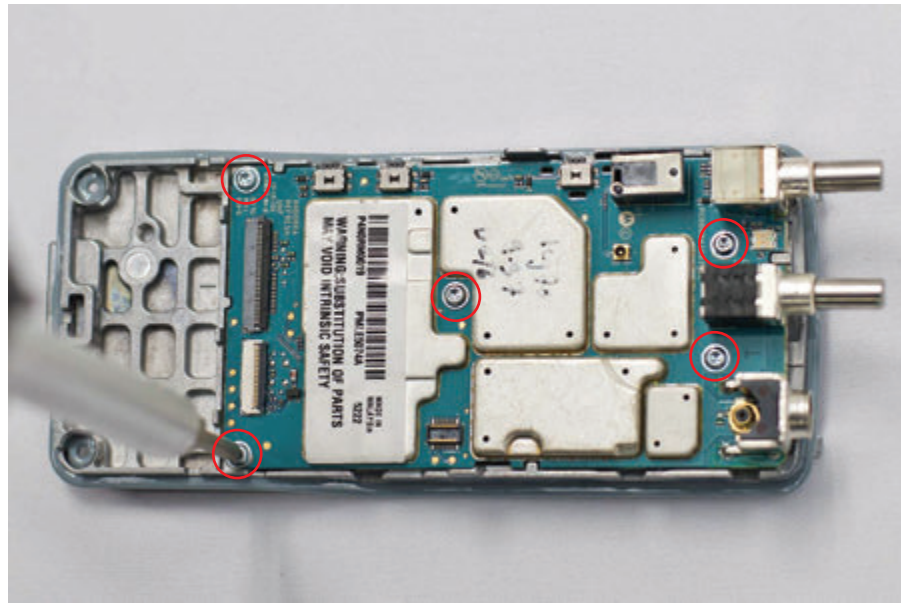

- 3 Remove the battery contact seal.

Figure 24: Battery contact seal removal



5.6.3

Keypad, Display, and Keypad Board Disassembly

Procedure:

- 1 Disconnect the UC-audio flex.

Figure 25: UC-audio flex removal

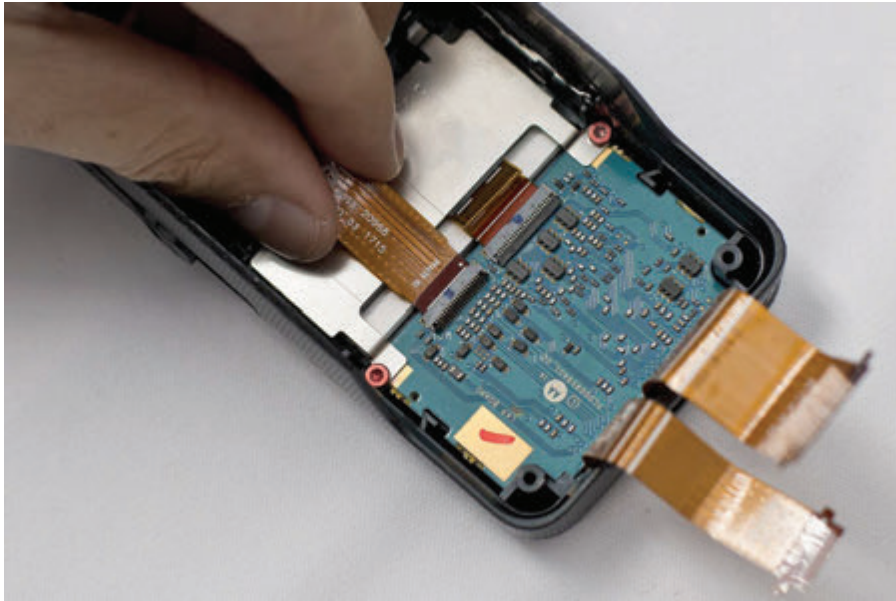

- 2 Remove the display retainer after removing the two K18 screws.

Figure 26: K18 screw removal

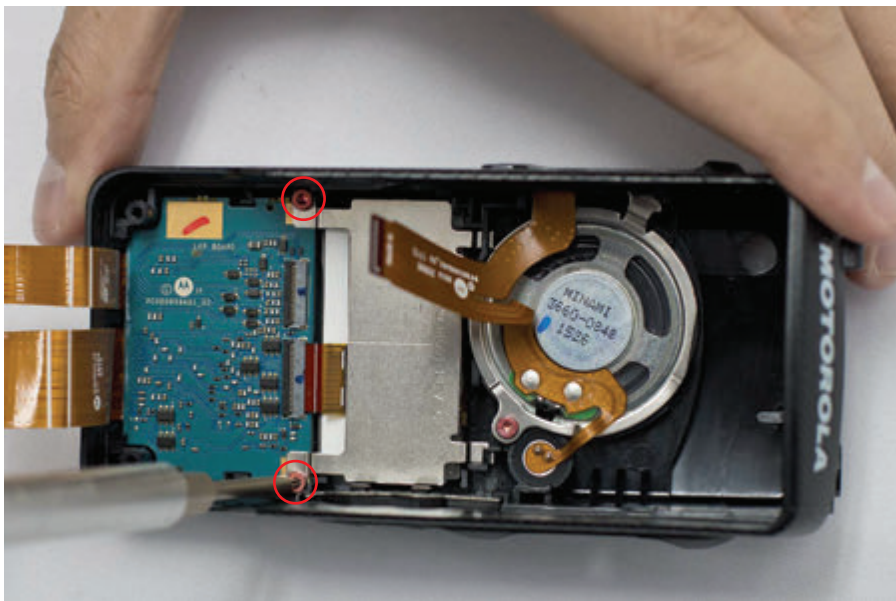

- 3 Disconnect the display flex from the keypad board and remove it from the front kit.

Figure 27: Display flex removal

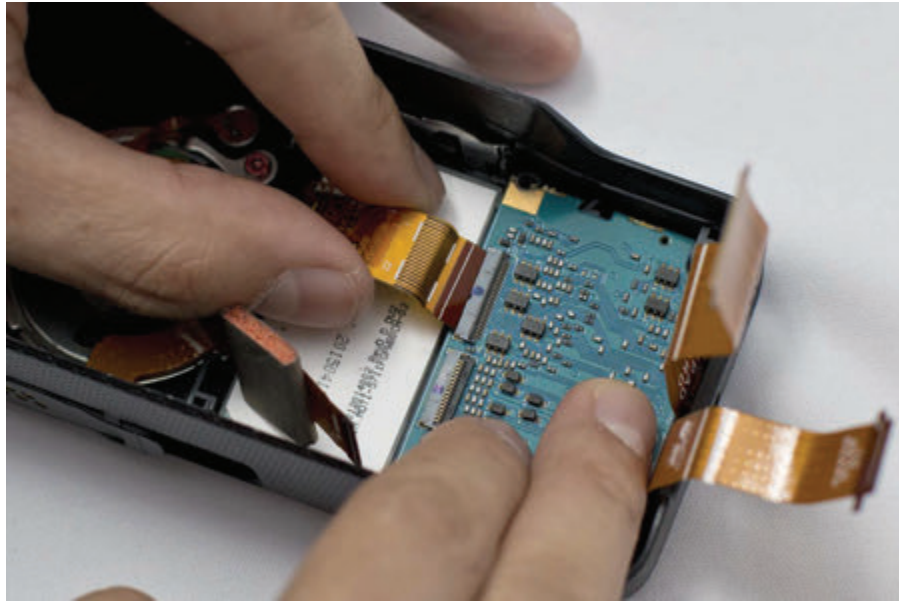

- 4 Remove the keypad and display module from the front kit.

Figure 28: Keypad removal

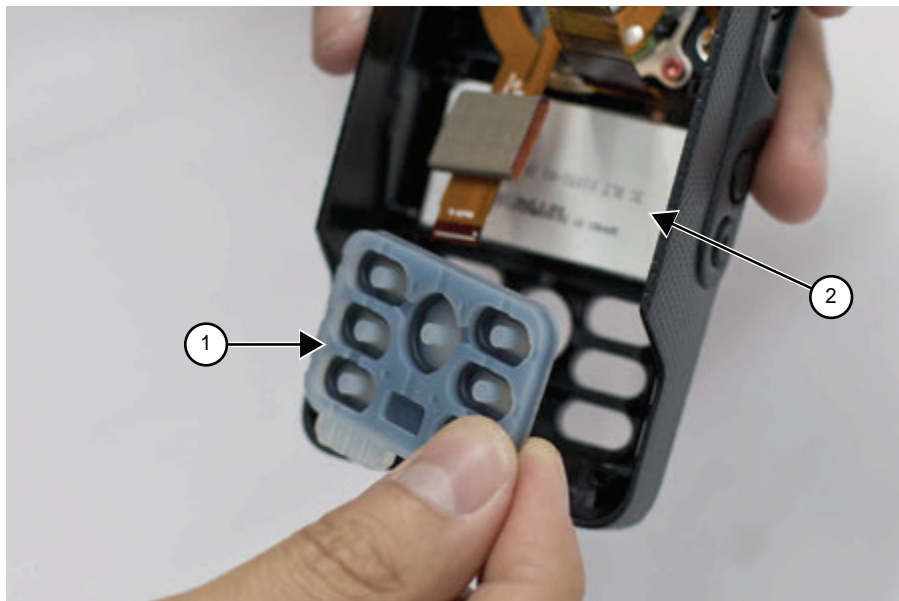

Label	Description
1	Keypad
2	Display Module

5.6.4

Side Button, Speaker, Microphone, and UC-Audio Flex Disassembly

Procedure:

- 1 Pull out the PTT retainer.

Figure 29: PTT retainer removal

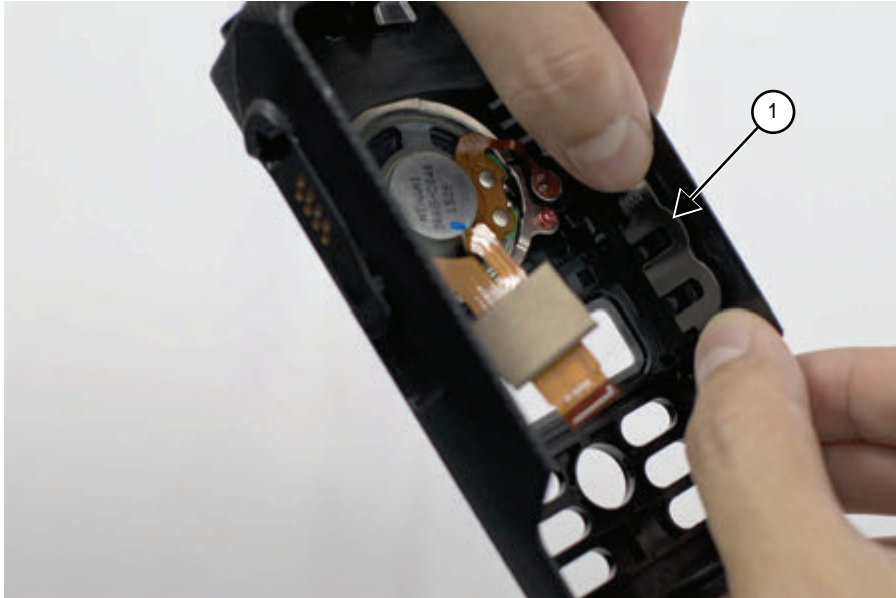

Label	Description
1	PTT Retainer

- 2 Remove the side button.

Figure 30: Side button removal

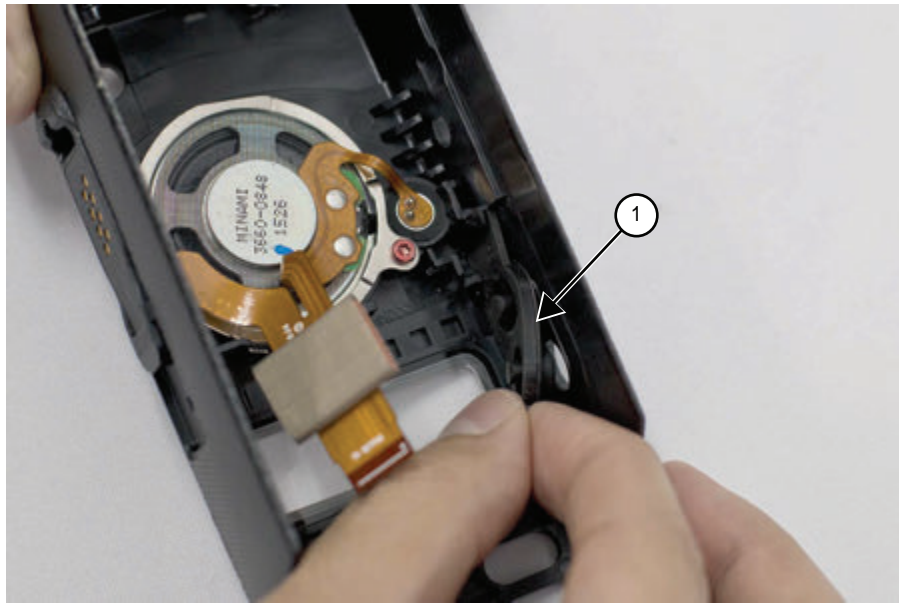

Label	Description
1	Side Button

- 3 Peel off the UC escutcheon.

Figure 31: UC escutcheon removal



- 4 Pull the UC-audio flex (adhesive held) FR4 from the front housing. Push the UC-audio flex through the UC slot into the housing.

Figure 32: UC-audio flex removal



- 5 Remove the K18 screw securing the speaker retainer.

Figure 33: Speaker retainer screw removal



- 6 Remove the speaker assembly from the front kit and separate the speaker module and retainer.

Figure 34: Speaker retainer removal



5.7

Detailed Radio Reassembly

The following content describes the detailed reassembly procedure of your radio.

5.7.1

Speaker Reassembly

Procedure:

- 1 Insert the UC-audio flex through the speaker retainer so that the speaker retainer is placed directly on the speaker assembly.

Figure 35: Speaker assembly

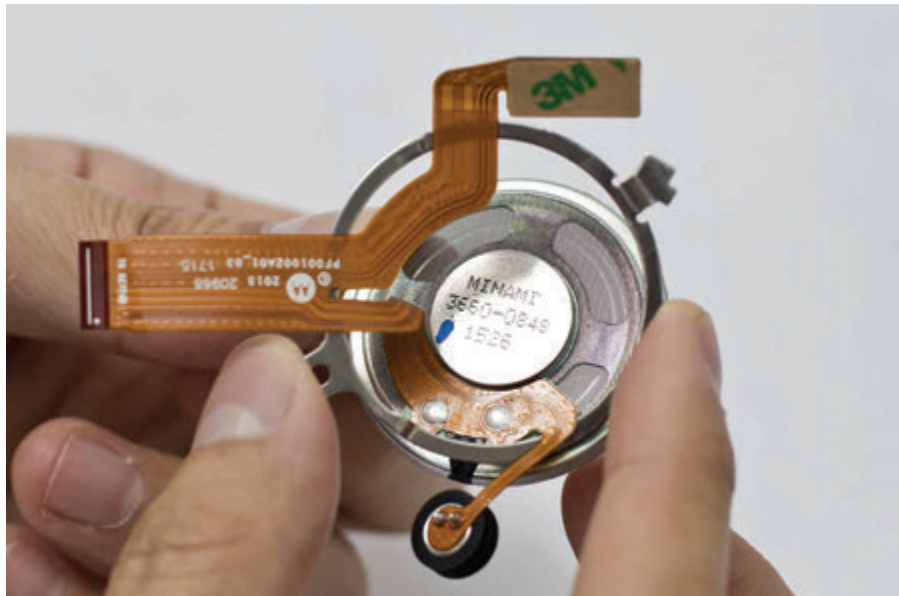



NOTICE: Ensure the flex is on top of the retainer to prevent it from being torn during reassembly.

- 2 Use tweezers to pull UC-audio flex circuit through the UC slot and place the speaker assembly in the recess on the front kit.

Figure 36: UC-audio flex



- 3 Replace with a new UC escutcheon.

Figure 37: UC escutcheon



- 4 Ensure the mic is seated properly in the mic boot. Screw in the K18 screw to the speaker retainer.

Figure 38: Speaker retainer reassembly

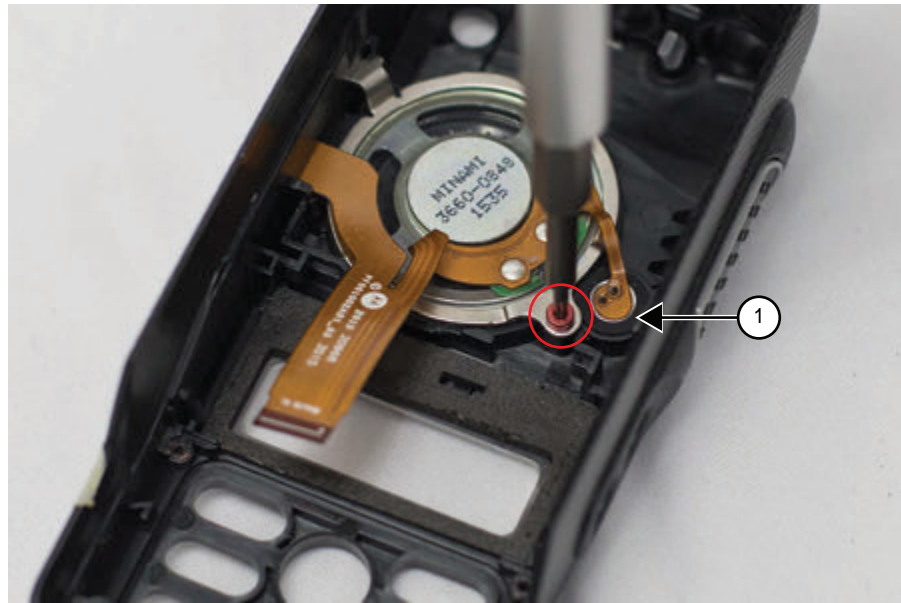

Label	Description
1	Mic

5.7.2

Side Button, Keypad, Display, and Keypad Board Reassembly

Procedure:

- 1 Insert side button to the front housing.

Figure 39: Side button reassembly



Label	Description
1	Side Button



NOTICE: Ensure the side button is seated firmly without any pinching as this impacts the sealing performance.

- 2 Replace the PTT retainer.

Figure 40: PTT retainer reassembly



Label	Description
1	PTT Retainer

- 3 Place the display module into the display module recess.

Figure 41: Display module reassembly



- 4 Place the keypad into the front kit and press firmly in place.

Figure 42: Keypad reassembly



NOTICE: Ensure the keypad mushroom rib is fully seated in the sealing groove to prevent any pinching or bulging.

- 5 Tongue in the keypad board.

Figure 43: Keypad board reassembly

- 6 Connect the display flex and gently latch it down.

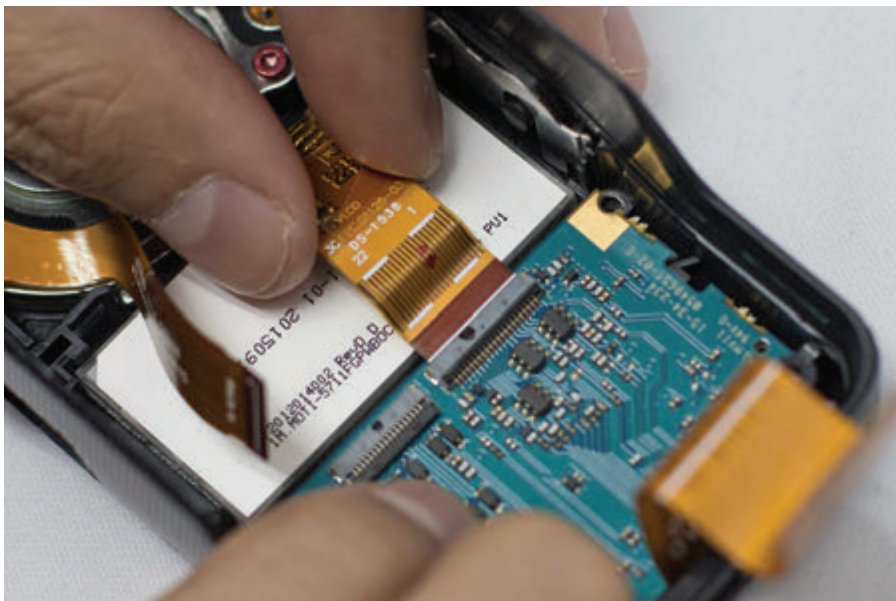
Figure 44: Display flex reassembly

- 7 Hold up the UC-audio flex and insert the display retainer. Screw in the K18 screw to the speaker retainer.

Figure 45: Speaker retainer reassembly



 **NOTICE:** Ensure the UC-audio flex is not trapped under the speaker retainer.

- 8 Connect the UC-audio flex to the keypad board and gently press the Zero Insertion Force (ZIF) connector until it latches shut.
- 9 Affix a poron pad on top of the UC-audio flex.

Figure 46: UC-audio flex pad reassembly

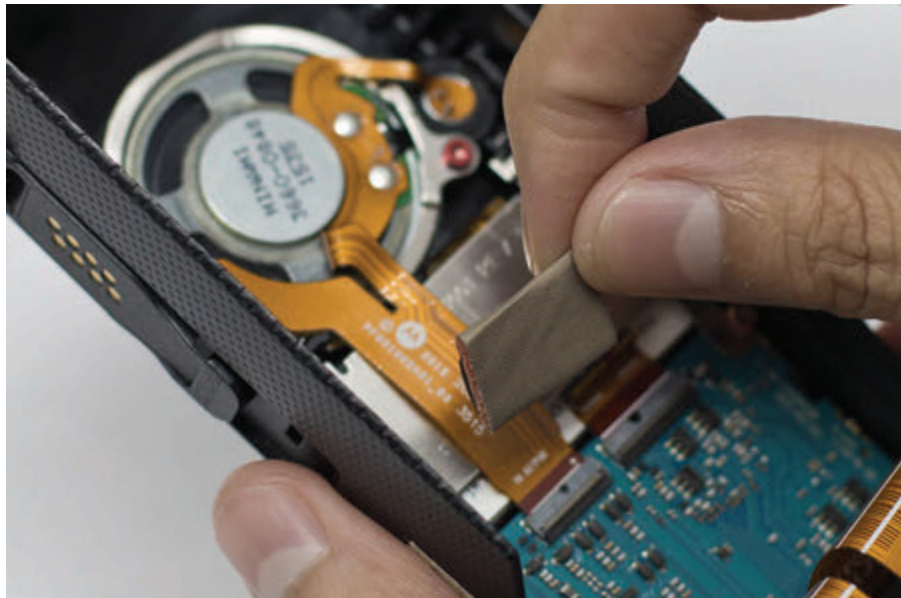

5.7.3

Back Kit Reassembly

Procedure:

- 1 Replace the thermal pad on the chassis.

Figure 47: Replace thermal pad

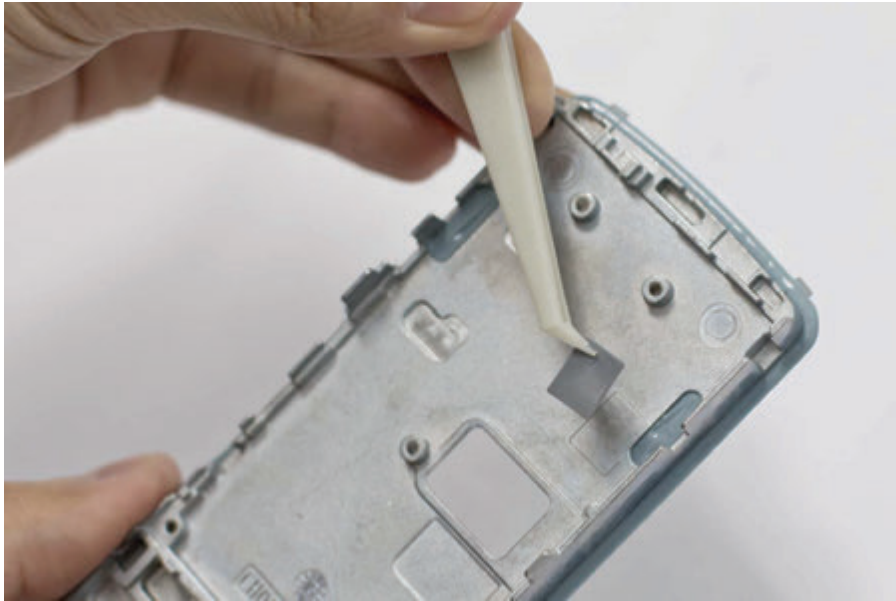

- 2 Affix the chassis label on both the left and right side of the chassis.

Figure 48: Affix chassis label

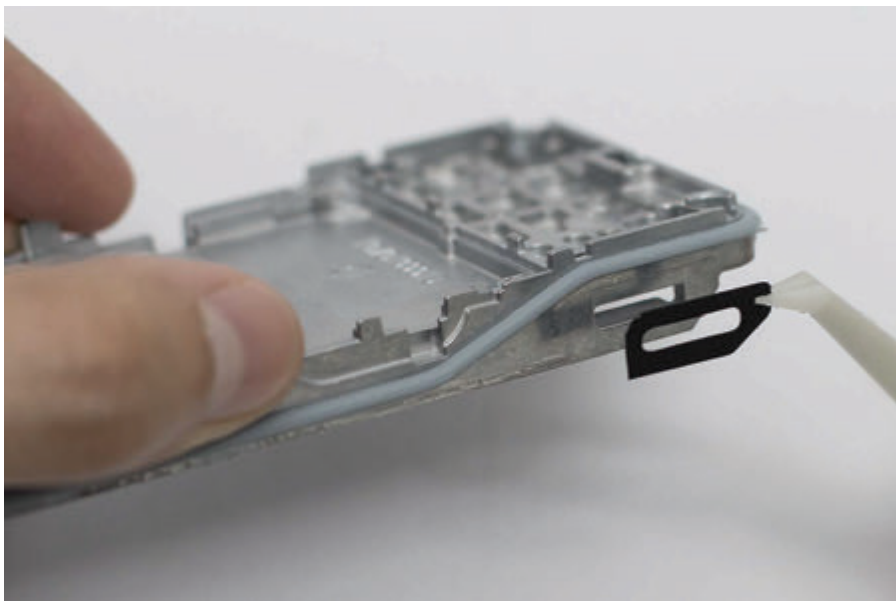

- 3 Replace battery contact seal on the chassis. Orientate the battery contact seal so that the wider edge is at the top side.

Figure 49: Battery contact seal reassembly

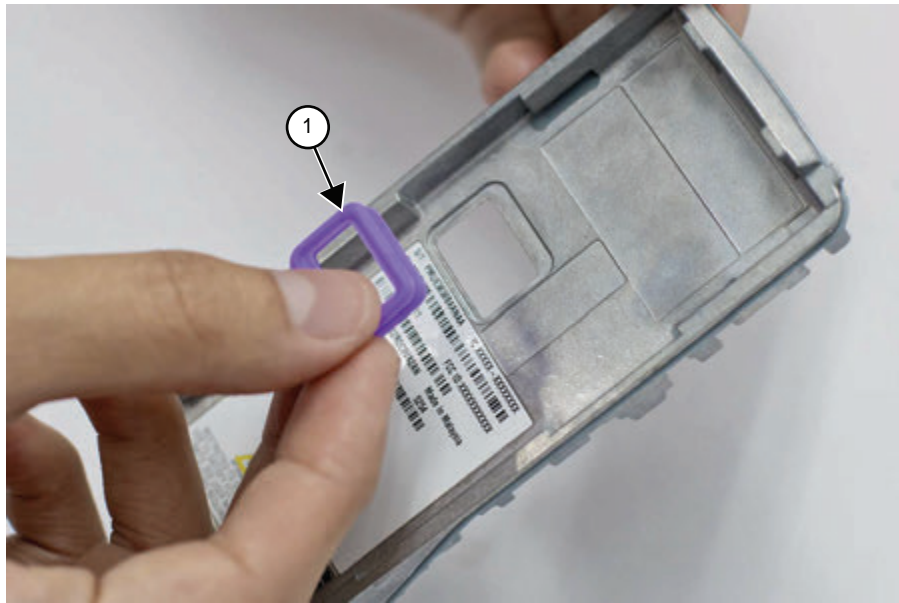

Label	Description
1	Wider Edge

CAUTION: Make sure the battery contact seal is not twisted or lifted when the mainboard assembly is placed on the chassis.

- Place the mainboard assembly on the chassis and replace the five M2 screws.

Figure 50: Mainboard reassembly

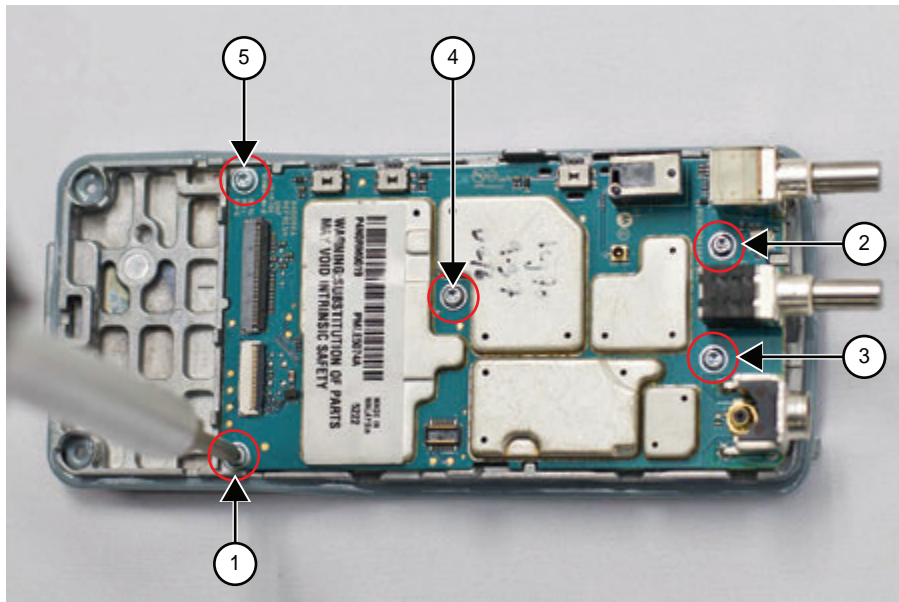

Label	Description
1-5	Five M2 screws

- 5 Insert the top control seal into the volume and channel shaft. Push on the wing of the top control seal as shown in [Figure 51: Top control seal reassembly on page 79](#), until it is seated on the base of the switches.

Figure 51: Top control seal reassembly

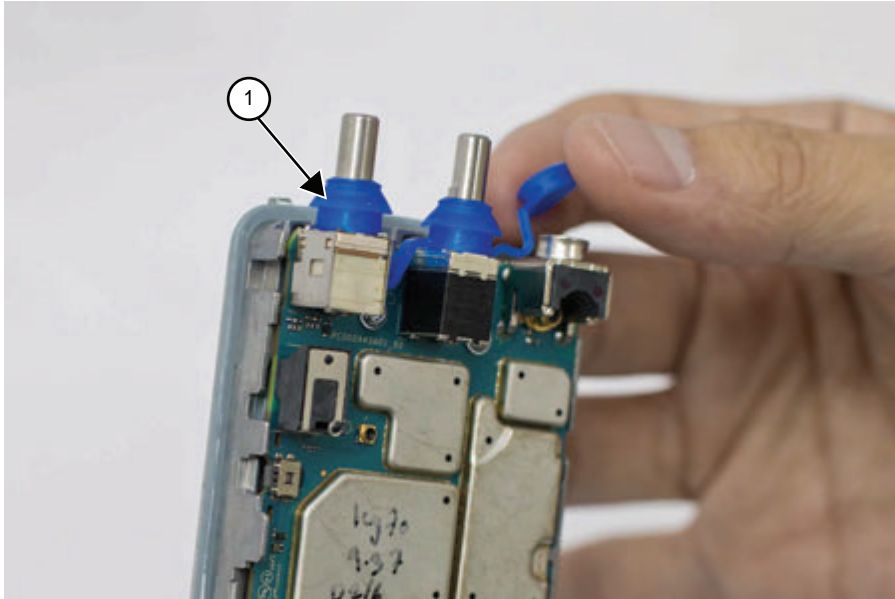

Label	Description
1	Wing



CAUTION: Ensure the top control seal is seated properly on the shafts.

5.7.4

Front Kit Reassembly

Procedure:

- 1 Apply a thin layer of grease to the full perimeter of the dispensed O-ring.
- 2 Connect the two flexes to the mainboard Zero Insertion Force (ZIF) connector and gently latch it firmly shut.

Figure 52: Interface flexes reassembly (Limited Keypad Model)

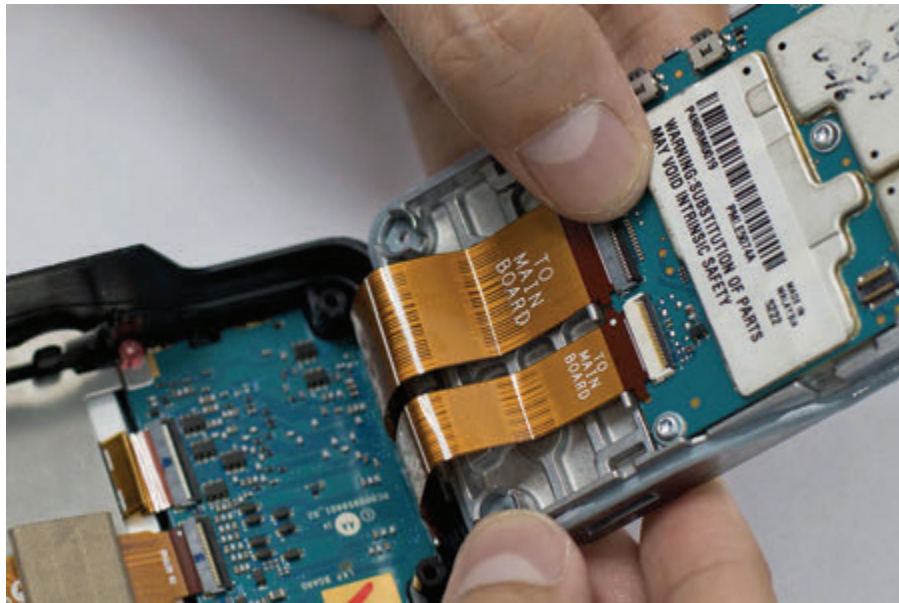
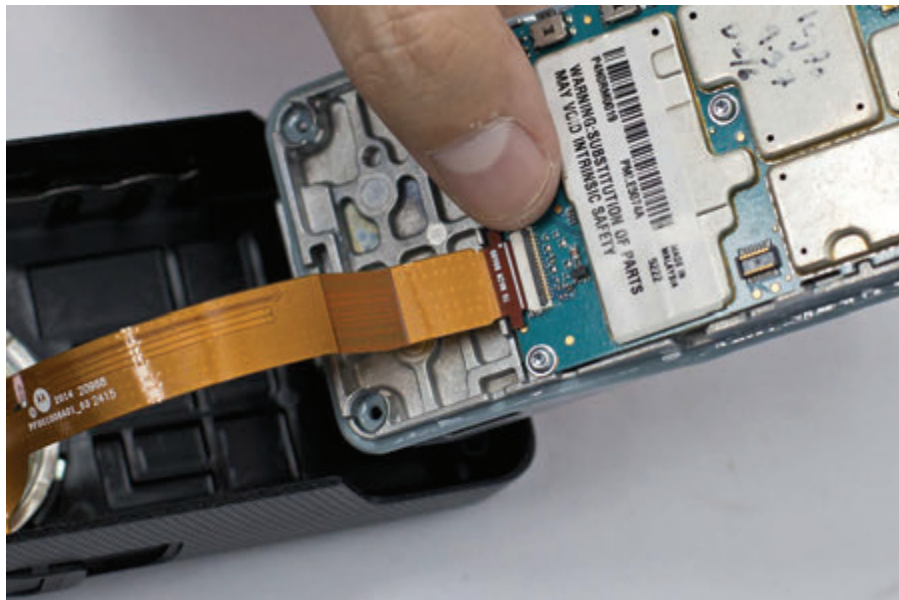

Figure 53: Interface flexes reassembly (Non-Keypad Model)



- 3 Slide the back kit into the front kit and firmly press down to snap it in.

Figure 54: Front kit reassembly

- 4 Fasten the two Front Kit-Back Kit screws by using TORX T6 screwdriver.
- 5 Slide in the volume and channel knob fully on the shafts on the front kit.

Figure 55: Knob reassembly

- 6 Attach antenna by turning it in clockwise.

Figure 56: Attaching the antenna



5.7.5

RF Plug Reassembly

Procedure:

- 1 Replace the RF plug by using tweezers.

Figure 57: RF Plug reassembly



- 2 If Motorola Solutions nameplate is damaged, remove nameplate with tweezers and replace a new one.

Figure 58: Nameplate replacement

- 3 Make sure the RF plug and nameplate are flushed to the housing and not bulging up. If it bulges up, disassemble and reassemble back.
- 4 If product nameplate is damaged, remove nameplate with tweezers and replace a new one.

Figure 59: Product nameplate reassembly

NOTICE: Maintain this area regularly, at least annually, to prolong battery contacts life and free interface from contamination.

5.8

Ensuring Radio Immersibility

This section discusses radio immersibility concerns, tests, and disassembly and reassembly of the radios.

5.8.1

Servicing

Radios shipped from the Motorola Solutions factory have passed vacuum testing and are capable of restoring the watertight integrity of your radio.



CAUTION: It is strongly recommended to defer your radio maintenance to qualified service personnel and service shops. This is of paramount importance as service by unauthorized persons may cause irreparable damage to your radio. If disassembly is necessary, unauthorized attempts to repair the radio may void any existing warranties or extended performance agreements with Motorola Solutions. It is also recommended for qualified service personnel/workshop that is authorized by Motorola Solutions to perform annual check on your radio immersibility.

5.8.2

Accidental Immersion

If radio is accidentally dropped into water, shake your radio to remove the excess water from the speaker grille and microphone port area before operating. Otherwise, the sound may be distorted until water has evaporated, or is dislodged from these areas.

5.8.3

Specialized Test Equipment

This section summarizes the specialized test equipment necessary for testing the integrity of the radios.

To ensure that the radio is truly a watertight unit, special testing, test procedures, and specialized test equipment are required. The special testing involves a vacuum check of the radio and pressure testing (troubleshooting) for water leaks if the vacuum check fails. The specialized test equipment/instrument mentioned in the "Service Aids" chapter is authorized by Motorola Solutions and needed to perform the vacuum check and pressure testing, if required. Any equipment/tools/instruments not mentioned in this chapter must not be used to perform these tests.

5.8.4

Vacuum Pump Kit

The vacuum pump kit includes a vacuum pump with gauge, and a vacuum hose.

A connector fitting (5871134M01) and fitting seal (3271133M01) pump connector, which must be ordered separately, connects the vacuum hose to the radio chassis.

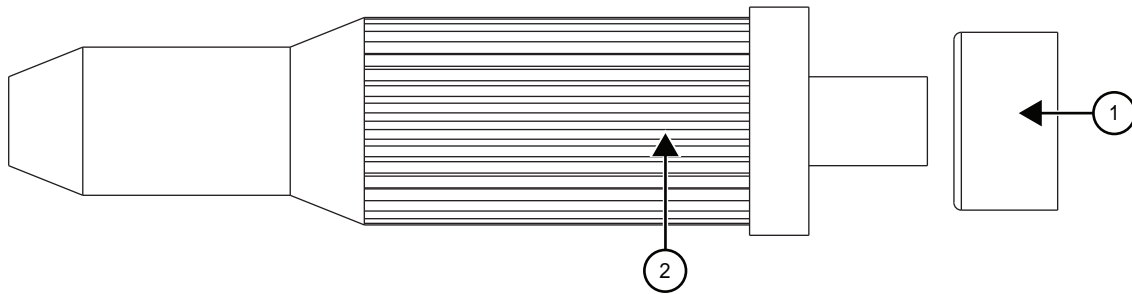
Figure 60: Connector Fitting - Fitting Seal Pump Connector

Label	Description
1	Fitting Seal
2	Connector Fitting

5.8.5**Pressure Pump Kit**

The pressure pump kit includes a pressure pump with gauge, and a pressure hose.

With the vacuum pump kit, the connector fitting - fitting seal pair connects the pressure hose to the radio chassis.

5.8.6**Miscellaneous Hardware**

Other items needed for testing radio immersibility are:

- Large water container
- Deionized (DI) water
- A supply of replacement parts: Battery Contact Seal, Breathing Vent Label, and Breathing Vent Membrane.

5.8.7**Vacuum Test**

The vacuum test uses a vacuum pump and gauge. The pump creates a vacuum condition inside the radio, and the gauge monitors the radio for a stable vacuum reading; that is, checking for a properly sealed, watertight unit.

Prerequisites:

- Remove the battery.
- Remove the universal connector dustcover to expose the universal connector.
- Remove the breathing vent label and breathing vent membrane.

Procedure:

- 1 Attach antenna firmly to the radio.
- 2 Attach the vacuum hose to the vacuum pump. Check the pump and hose for leaks by blocking off the open end of the hose and operating the pump a few times.

The actual reading of the gauge at this point is not important; it is important that the gauge pointer remained steady, indicating no vacuum leaks in the pump.

- 3 Ensure that the fitting seal is attached to the hose-to-chassis pump connector. Screw the pump connector into the tapped hole in the chassis.



CAUTION: Do not bend or over tighten pump connector to the chassis.

- 4 Attach the open end of the hose to the pointed end of the pump connector.
- 5 Place the radio on a flat surface with the chassis facing upward.
- 6 Operate the pump until the gauge indicates 6 in. Hg of vacuum on the radio. Observe the gauge for approximately 1 min.
 - If the needle falls 0.5 in. Hg or less (one scale interval, for example, from 3 in. Hg to 2.5 in. Hg), then the radio has passed the vacuum test and is approved for immersibility. No additional testing will be required.
 - If the needle falls more than 0.5 in. Hg (one scale interval, for example, from 3 in. Hg to less than 2.5 in. Hg), then the radio has failed the vacuum test and the radio might leak if immersed. Additional troubleshooting of the radio will be required; complete this procedure, then go to [Pressure Test on page 86](#).
- 7 Remove the vacuum hose and pump connector from the radio.

5.8.8

Pressure Test

Pressure testing involves creating a positive pressure condition inside your radio, immersing radio in water, and observing radio for a stream of bubbles (leak). Since all areas of your radio are being checked, observe the entire unit carefully for the possibility of multiple leaks before completing this test.



NOTICE: Pressure testing the radio is necessary only if the radio has failed the vacuum test. Do not perform the pressure test until the vacuum test has been completed.

Procedure:

- 1 Screw the pump connector (with fitting seal) into the tapped hole in the chassis.
- 2 Attach one end of the pressure hose to the pump connector and the other end to the pressure pump.
- 3 Attach antenna firmly to your radio.
- 4 Operate the pump until the gauge reads approximately 1 psig.



CAUTION: Pressure any greater than 1 psig might push air around the main seal.

- 5 Maintain the pressure at 1 psig and immerse the radio into a water-filled container.
- 6 Watch for any continuous series of bubbles.

A stream of bubbles indicates a sign of leakage. Some air entrapment may cause the accumulation of bubbles, especially in the grille area, but the bubbles should not be continuous.



CAUTION: Do not bend or over tighten pump connector to the chassis.

- 7 Note all of the seal areas that show signs of leakage.

Pinpoint the problem to the following areas:

- Front Housing
- Chassis kit
- Battery Contact Seal

- 8 Remove the radio from the water container, and dry the radio thoroughly.



CAUTION: Keep the area around the chassis vacuum port dry by ensuring that there is no water around it.



NOTICE: Dry the area around the main seal with extra care to prevent contamination of the internal electronics while the unit is open.

- 9 Remove the pump connector from the chassis.

Postrequisites: After performing Pressure Test, your radio must undergo baking process in a temperature chamber for constant temperature soaking at 60 °C for 1 hour. This is to ensure no moisture is trapped inside the radio and prevent contamination of the internal electronics after reassembling the radio.

5.8.9

Troubleshooting Leak Areas

Before repairing any leak, read steps in the applicable section. This helps to eliminate unnecessary disassembly and reassembly of a radio with multiple leaks.

Troubleshoot only the faulty seal areas listed in [Pressure Test on page 86](#), and when multiple leaks exist, in the order listed.



NOTICE:

Before reassembling the radio, always install a Battery Contact Seal in the defective area.

5.8.9.1

Front Housing Troubleshooting

Procedure:

Do one or both of the following:

- If a leak occurs at the Lens (Display Models only), Universal Connector, Chassis/Housing interface, or PTT button area of the housing, replace the housing, refer to [Detailed Radio Disassembly on page 58](#).
 - 1 Remove the housing assembly from the radio.
 - 2 Discard the housing assembly.
 - 3 Install a new housing assembly to the radio.
- If the leak occurs at the control top area, remove the knobs in order to determine the leak location:
 - 1 Conduct the Pressure Test.
 - 2 Identify the leak location.

5.8.9.2

Replacing Battery Contact Seal

Procedure:

- 1 Remove the Battery Contact Seal from the Chassis. Refer to "Radio Disassembly" Chapter.
- 2 Inspect the Battery Contact Seal, Chassis, and surrounding areas for foreign material that might prevent the Battery Contact Seal from sealing properly.
- 3 Install a new Battery Contact Seal, discard the old Seal.
- 4 Reassemble the Chassis assembly followed by installing into Front Kit. Refer to "Radio Reassembly" Chapter.

5.8.9.3

Replacing Chassis Assembly

Procedure:

- 1 Remove the chassis assembly from the radio. Refer to [Front Kit from Chassis Disassembly on page 58](#).
- 2 Remove the Mainboard from chassis. Refer to [Back Kit Disassembly on page 63](#).
- 3 Assemble a new chassis assembly; discard the old chassis assembly.
- 4 Reassemble the chassis assembly followed by installing into front kit. Refer to [Detailed Radio Reassembly on page 70](#).

5.8.9.4

Replacing Ventilation Seal and Ventilation Label

Prerequisites: Both Ventilation Label and Gasket need to be replaced after vacuum test, pressure test, or water leakage troubleshooting.

Procedure:

- 1 Remove the Ventilation Label that covers the Ventilation Seal from the chassis.
- 2 Remove the Ventilation Seal.
- 3 Ensure that the chassis surface (at the Ventilation Label and Ventilation Seal recess) is clean, no/minimum scratches and free from any adhesive or other foreign materials.
- 4 Install a new Ventilation Seal, covering the vent port hole, in the small recessed area in the chassis. Ensure that no oily substance is in contact with the seal.
- 5 Install a new Ventilation Label over the Ventilation Seal in the larger recessed area in the chassis. Press down evenly over the label surface to ensure good adhesion.

5.8.9.5

Battery Maintenance

Maintain your radio battery annually or as required; when battery contacts are dirty or show signs of wear. Battery Maintenance prolongs battery contacts life and free battery interface from contamination.

It is recommended that the Battery Radio-side and Charger-side contacts are cleaned with DeoxIT GOLD cleaner/lubricant.

DeoxIT GOLD (Supplier CAIG Labs, part number: G100P) cleaner/lubricant pen is very effective at cleaning and extending the life of the battery contacts. DeoxIT GOLD cleaner/lubricant pen is available at numerous electronics suppliers (Radio Shack, McMaster Carr, Fry's, and more) and directly from manufacturer, CAIG Labs, at <http://www.caig.com>.

This pen-based package is recommended as it provides better access to the recessed contacts of the battery. The pen tip may need to be modified (trimmed on the sides) to improve penetration into the battery contact slots.

Advanced contact wear is defined as wear through the contact platings (gold and nickel) to the base metal (copper). Copper exposure is characterized by a distinctive orange-brown metal appearance surrounded by silvery nickel underplate and gold top coat.

In some cases, a magnified (10 times minimum) inspection may be required to verify wear through to the base material. Polishing of the gold or nickel surface is common and is not considered as a need for replacement. Replace battery when advanced wear is evident.

5.8.9.5.1

Maintaining the Battery**Procedure:**

- 1 Shake the lubricant pen until the fluid begins to flow.
- 2 Wipe battery contact surface with felt tip.
- 3 After cleaning the contact areas of any foreign material, let the lubricant/cleaner dry for 2 minutes.
- 4 Replace the battery on the radio
- 5 Move battery relative to the radio to test for intermittency.

Postrequisites: After cleaning, inspect the contact surfaces for signs of advanced contact wear. See [Battery Maintenance on page 88](#) for advanced contact wear.

5.8.10 Troubleshooting Charts

Figure 61: Troubleshooting Flow Chart for Vacuum Test (Sheet 1 of 2)

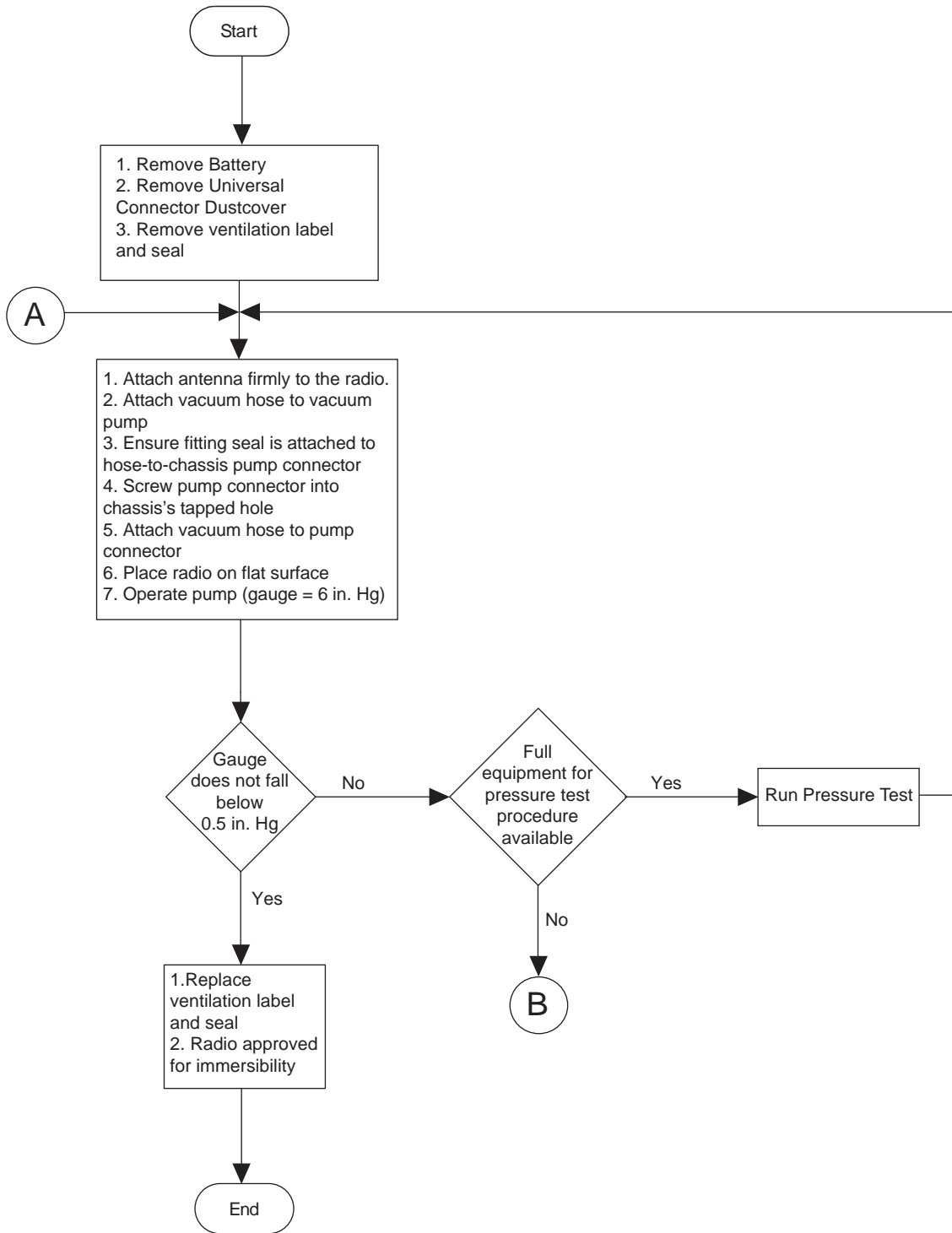

Figure 62: Troubleshooting Flow Chart for Vacuum Test (Sheet 2 of 2)

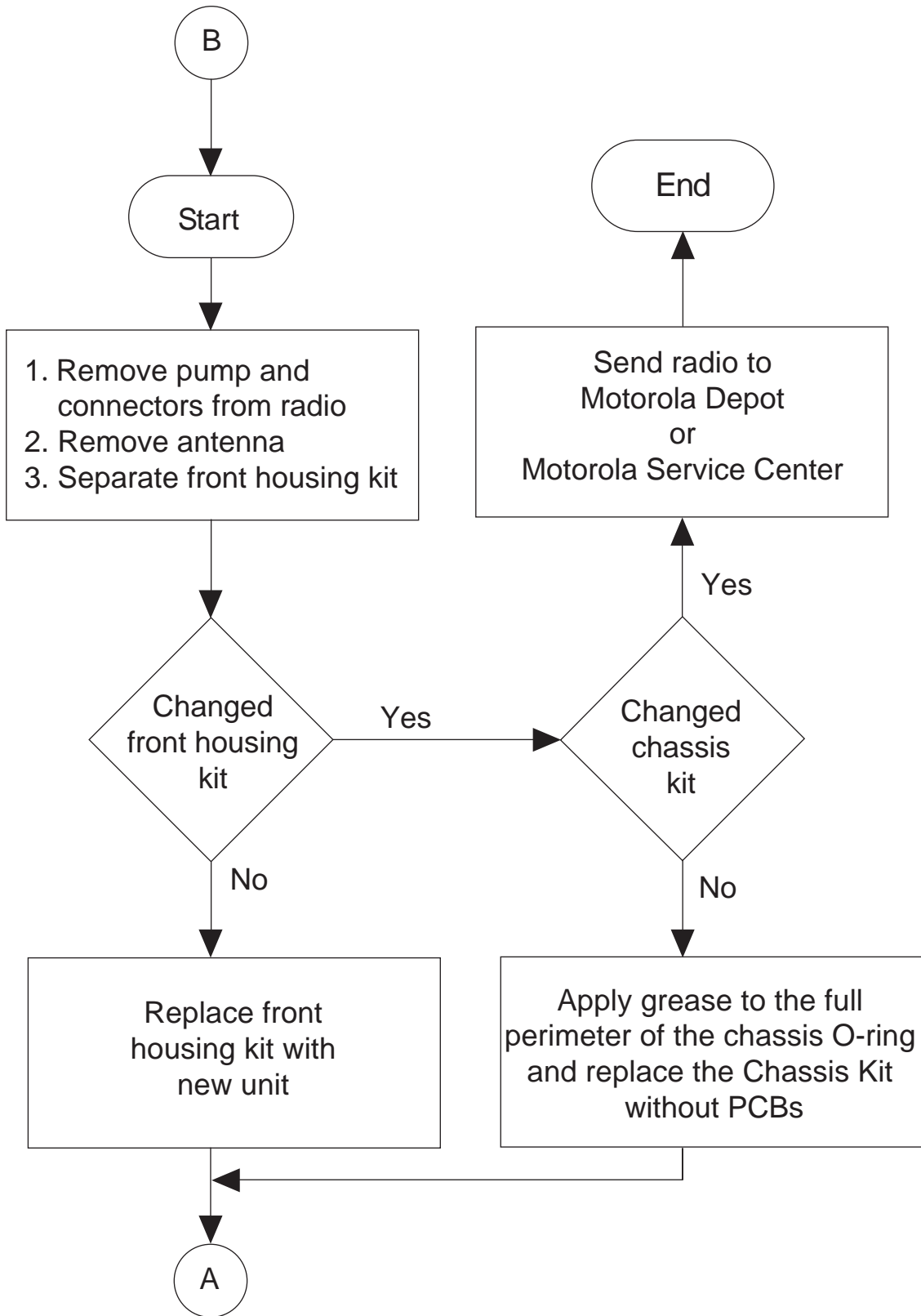
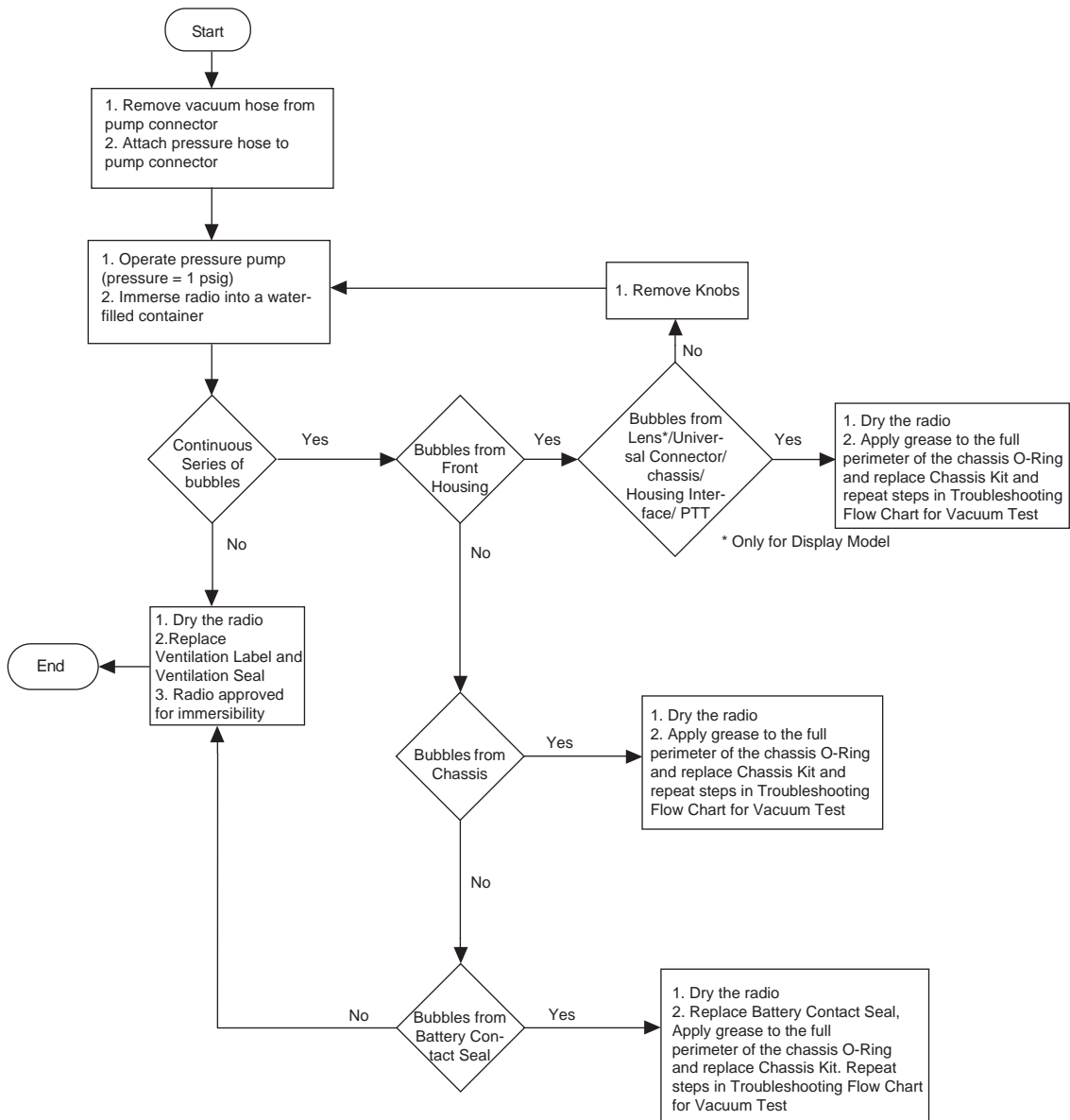

Figure 63: Troubleshooting Flow Chart for Pressure Test and Leakage Areas



5.9

Radio Exploded Mechanical View and Parts List

5.9.1

Limited Keypad Model

Figure 64: Limited Keypad Model Exploded View

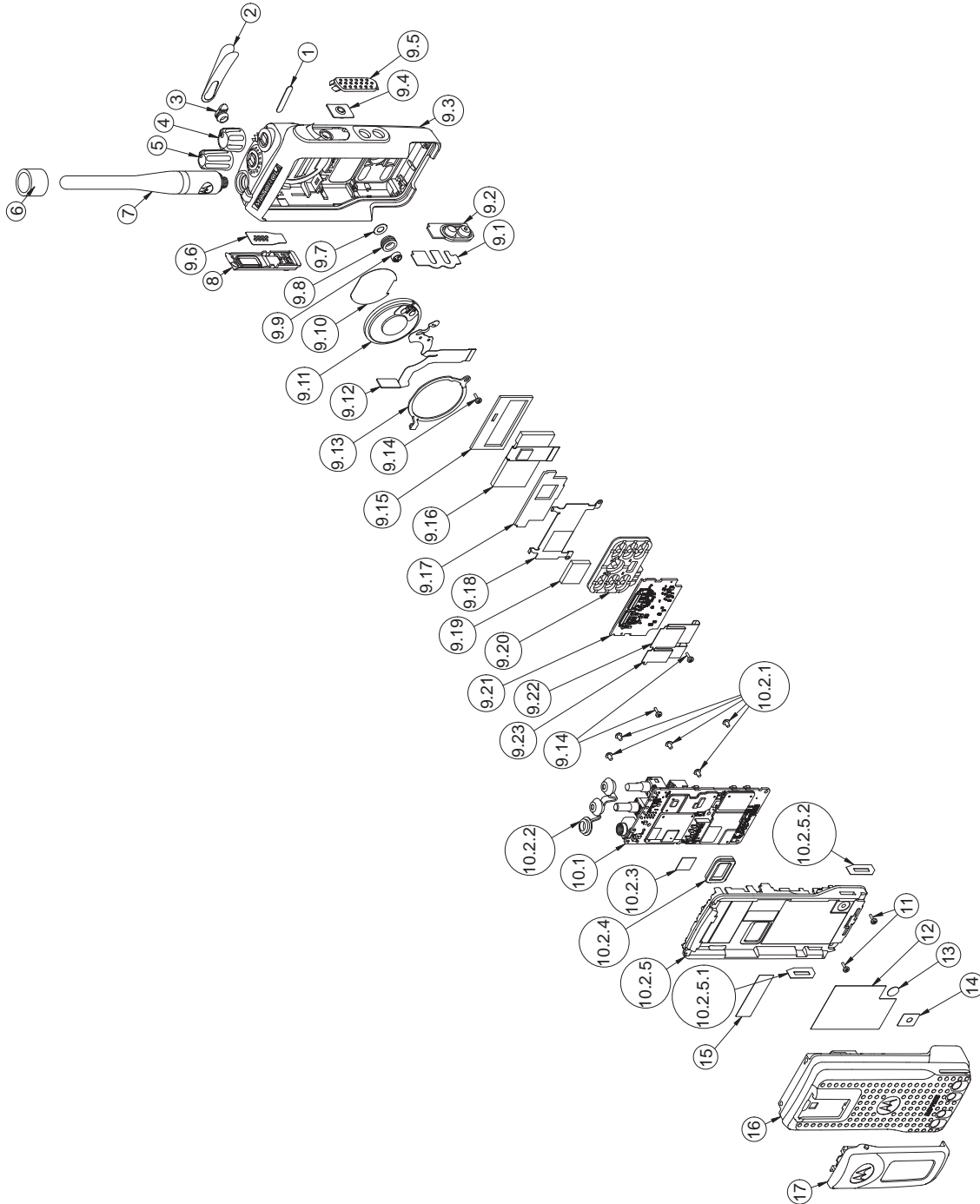

Table 32: Limited Keypad Model Exploded View Parts List

Label	Description	Part Number
1	Nameplate (Product Number)	Refer to Additional Parts List on page 98

Label			Description	Part Number
2			Nameplate (Motorola Solutions)	33012026001
3			RF Plug	38012018001
4			Volume Knob	36012016001
5			Channel Knob	36012017001
6			Antenna ID Band	Refer to Additional Parts List on page 98
7			Antenna	Refer to Additional Parts List on page 98
8			Aesthetic Cover	0104058J40
9			Front Kit	PMLN7271_
	9.1		PTT Retainer	42012035001
	9.2		Side Button	KP000087A01
	9.3		Housing Assembly	0104067J09
	9.4		PTT Keypad	KP000086A01
	9.5		PTT Paddle	HN000696A01
	9.6		UC Escutcheon	33012020001
	9.7		Microphone Membrane	SL000209A01
	9.8		Microphone Boot	SL000208A01
	9.9		Microphone	50012012001
	9.10		Speaker Mesh	HW000738A01
	9.11		Speaker	AC000028A02
	9.12		UC-Audio Flex	PF001002A01
	9.13		Speaker Retainer	42012044001
	9.14		K18 Screw (Keypad-Display Retainer and Speaker Retainer)	0385273D06
	9.15		Front Display Poron	75012078001
	9.16		Display Module (2-Line Monochrome)	72012014002
	9.17		Back Display Poron	HW000757A01
	9.18		Display Retainer	42012034001
	9.19		Conductive Pad	75012147001
	9.20		Limited Keypad	75012080001
	9.21		Keypad Board Assembly	0104065J98
	9.22		Interface Keypad-Display Flex	PF001004A01
	9.23		Interface UC-Audio Flex	PF001005A01

Label				Description	Part Number
10				Back Kit	Refer to Additional Parts List on page 98
	10.1			Main Board Assembly	Part of Back Kit
	10.2			Chassis Assembly	PMLN7273_
		10.2.1		M2 Screw (Main Board Assembly)	03012034001
		10.2.2		Top Control Seal	32012269001
		10.2.3		Thermal Pad	75012234001
		10.2.4		Battery Contact Seal	32012110001
		10.2.5		Chassis (With dispensed O-Ring)	0104067J11
			10.2.5.1	Chassis Left Label	LB000706A01
			10.2.5.2	Chassis Right Label	LB000706A02
11				Front Kit-Back Kit Screw	0316281H01
12				Compro Label	LB000560A01
13				Ventilation Seal	3286058L01
14				Ventilation Label	LB000256A01
15				UL Label (Repaired)	LB000559A02 (For UL radio, need to replace with UL Label (Repaired) for all repaired radios)
16				Battery	Refer to Additional Parts List on page 98
17				Belt Clip	Refer to Additional Parts List on page 98

5.9.2 Non-Keypad Model

Figure 65: Non-Keypad Model Exploded View

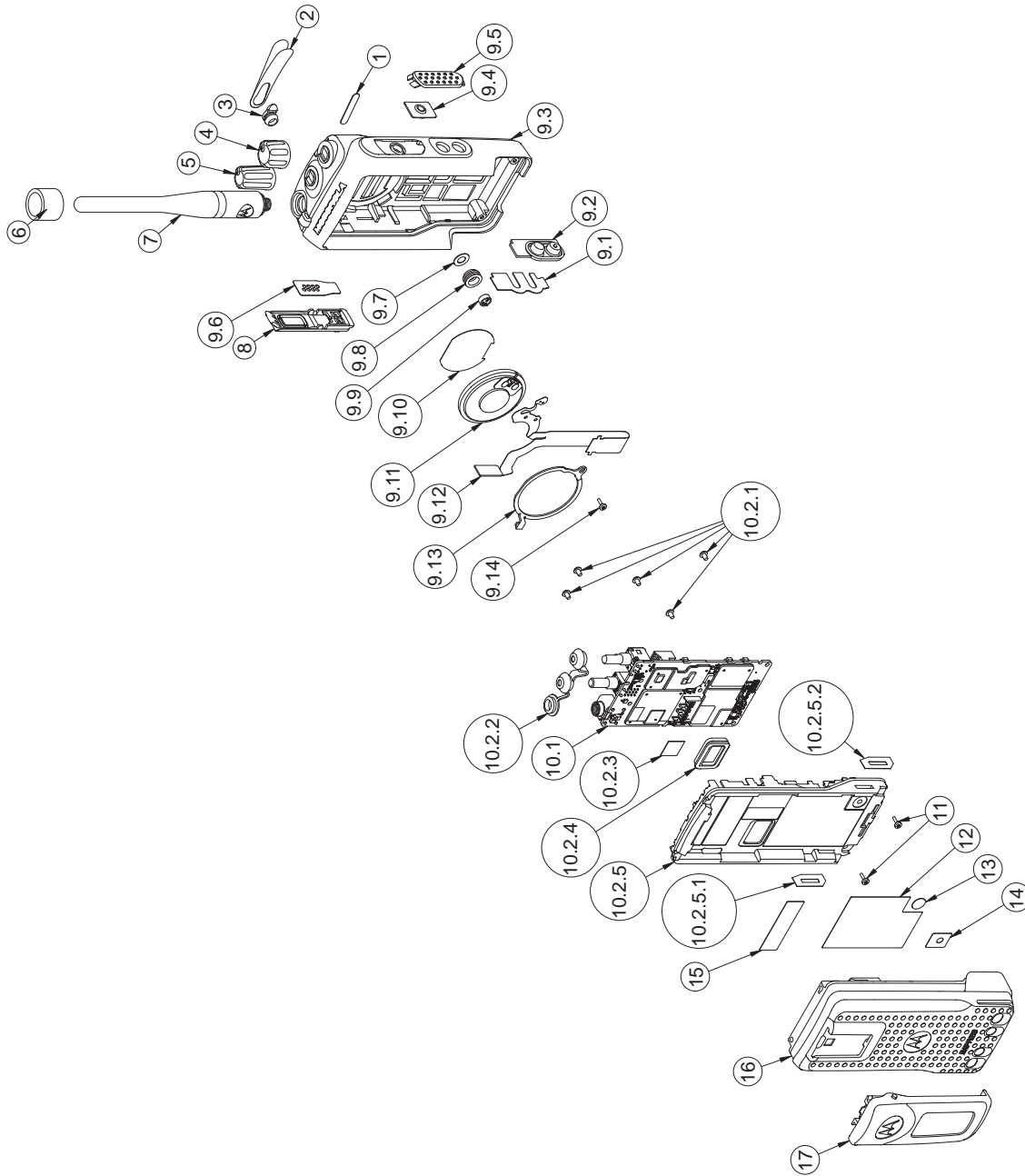

Table 33: Non Keypad Model Exploded View Parts List

Item	Description	Part Number
1	Nameplate (Product Number)	Refer to Additional Parts List on page 98
2	Nameplate (Motorola Solutions)	33012026001

Item				Description	Part Number
3				RF Plug	38012018001
4				Volume Knob	36012016001
5				Channel Knob	36012017001
6				Antenna ID Band	Refer to Additional Parts List on page 98
7				Antenna	Refer to Additional Parts List on page 98
8				Aesthetic Cover	0104058J40
9				Front Cover Kit	PMLN7272_
	9.1			PTT Retainer	42012035001
	9.2			Side Button	KP000087A01
	9.3			Housing Assembly	0104067J10
	9.4			PTT Keypad	KP000086A01
	9.5			PTT Paddle	HN000696A01
	9.6			UC Escutcheon	33012020001
	9.7			Microphone Membrane	SL000209A01
	9.8			Microphone Boot	SL000208A01
	9.9			Microphone	50012012001
	9.10			Speaker Mesh	HW000738A01
	9.11			Speaker	AC000028A02
	9.12			UC-Audio Flex	PF001006A01
	9.13			Speaker Retainer	42012044001
	9.14			K18 Screw (Keypad-Display Retainer and Speaker Retainer)	0385273D06
10				Back Kit	Refer to Additional Parts List on page 98
	10.1			Main Board Assembly	Part of Back Kit
	10.2			Chassis Assembly	PMLN7273_
		10.2.1		M2 Screw (Main Board Assembly)	03012034001
		10.2.2		Top Control Seal	32012269001
		10.2.3		Thermal Pad	7515526H01
		10.2.4		Battery Contact Seal	32012110001
		10.2.5		Chassis (With dispensed O-Ring)	0104067J11
			10.2.5.1	Chassis Left Label	LB000706A01
			10.2.5.2	Chassis Right Label	LB000706A02

Item				Description	Part Number
11				Front Kit-Back Kit Screw	0316281H01
12				Compro Label	LB000560A01
13				Ventilation Seal	3286058L01
14				Ventilation Label	LB000256A01
15				UL Label (Repaired)	Non-field replaceable
16				Battery	Refer to Additional Parts List on page 98
17				Belt Clip	Refer to Additional Parts List on page 98

5.9.3

Additional Parts List

This list consists of parts compatible to your radio.

Table 34: Batteries

Item	Part Number
Core Slim Li-Ion 1500 mAH	PMNN4406_
Core NIMH 1300 mAH	PMNN4415_
IMPRES Li-Ion 1500 mAH	PMNN4417_
IMPRES Li-Ion Non-FM 2150 mAH	PMNN4418_
Core Li-Ion 2450 mAH IP68	PMNN4543_
IMPRES Li-Ion 2450 mAH IP68	PMNN4544_

Table 35: Nameplates

Item	Part Number
XPR 3300e	33012039025
XPR 3500e	33012039026

Table 36: Back Kits

Item	Part Number
Back Cover Kit, 136–174 MHz, 5 W, Limited Keypad Portable	PMLD4733_S
Back Cover Kit, 136–174 MHz, 5 W, Limited Keypad Portable	PMLD4734_S
Back Cover Kit, 136–174 MHz, 5 W, Non-Key-pad Portable	PMLD4737_S
Back Cover Kit, 300–360 MHz, 4 W, Non-Key-pad Portable	PLMLD4749_

Item	Part Number
Back Cover Kit, 350–400 MHz, 4 W, Limited Keypad Portable	PMLD4755_S
Back Cover Kit, 350–400 MHz, 4 W, Limited Keypad Portable	PMLD4800_S
Back Cover Kit, 350–400 MHz, 4 W, Non-Keypad Portable	PMLD4799_S
Back Cover Kit, 403–527 MHz, 4 W, Limited Keypad Portable	PMLE5074_S

Table 37: Antenna ID Band (in pack of 10 pieces)

Item	Part Number
Grey	32012144001
Yellow	32012144002
Green	32012144003
Blue	32012144004
Purple	32012144005

Table 38: Belt Clips

Item	Part Number
2 in. belt clip	PMLN4651_
2.5 in. belt clip	PMLN7008_

Chapter 6

Basic Troubleshooting

This chapter contains error codes and board replacement procedures.

If the board does not pass all the performance checks in [Transceiver Performance Testing on page 35](#) or exhibits an error code listed below, then the circuit board should be replaced. If repair requires knowledge of details of component level troubleshooting, please send the radio to a Motorola Solutions Service Center.

To access the various connector pins, use the housing eliminator/test fixture along with the diagrams found in this section of the manual. See "Service Aids" for the appropriate Motorola Solutions service aids and tools part numbers.

6.1

Replacement Back Cover Kit Procedures

Once a problem has been isolated to a specific board, install the appropriate back cover kit (Refer to "Model Charts"), which is orderable from Motorola Solutions Radio Products and Solutions Organization.

If a board is replaced, it does not necessarily need to be retuned if it has been factory tuned. It should however be checked for performance before being placed into service. Of particular concern is the Bias DAC, which will need to be set for the appropriate final device bias current prior to keying up the radio. If the bias is not properly set it may be possible to cause damage to the transmitter.



CAUTION:

The Tuner Tool only allows the serial number of the blank board to be entered once. Be very attentive during this procedure.

6.2

Power-Up Error Codes

Upon powering up, the radio performs certain tests to determine if its basic electronics and software are in working order. Any error detected has an associated error code that is presented on the radio display.



NOTICE: Power-Up error codes are only applicable to Display Models only.

These error codes are intended to be used by a service technician when the radio generates the Self-Test Fail Tone. If these tests are successfully completed, the radio will generate the Self-Test Tone.



NOTICE: Non-display radios emit only the Self-Test Fail Tone if it fails the self-test.

There are two classes of detectable errors: fatal and non-fatal.

Fatal errors

Normal radio operation is inhibited when your radio encounters fatal errors.

Fatal errors include hardware errors detected by the microprocessor and certain memory errors.

These memory errors include incorrect ROM checksum, incorrect RAM checksum, and incorrect checksums of codeplug (Persistent Storage) blocks that contain operating parameters.

If the codeplug block operating parameters are corrupted, operation of the unit on the proper frequency, system, and group are in question.

Attempts to use this information could provide a false sense of security that others are receiving your messages.

Non-fatal errors

Corrupted codeplug blocks of call IDs, or their associated aliases are considered non-fatal errors.

Normal communication is still possible, but the user may be inconvenienced.

Table 39: Types of Error Code

Error Code	Description	Error Type	Corrective Action
ERROR 01/02	Call ID or associated aliases codeplug block checksum is wrong.	Non-Fatal	Normal communication is still possible, but the user may be inconvenienced. Reprogram codeplug.
ERROR 01/22	Tuning Codeplug block checksum is wrong.	Non-Fatal	Normal communication is still possible.
FAIL 01/82	External Codeplug block checksum is wrong.	Fatal	Reprogram codeplug.
FAIL 01/92	Secure Codeplug checksum error.	Fatal	Reprogram codeplug.
FAIL 01/A2	Tuning Codeplug block checksum is wrong.	Fatal	Reprogram codeplug.
FAIL 01/81	ROM Checksum is wrong.	Fatal	Reprogram FLASH Memory, then retest.
FAIL 01/88	Radio RAM test failure.	Fatal	Retest radio by turning it off and turning it on again.
FAIL 01/90 or FAIL 02/90	General hardware test failure.	Fatal	Retest radio by turning it off and turning it on again.
FAIL 02/81	DSP ROM Checksum is wrong.	Fatal	Reprogram FLASH Memory, then retest.
FAIL 02/82	DSP RAM1 test failure.	Fatal	Retest radio by turning it off and turning it on again.
FAIL 02/84	DSP RAM2 test failure.	Fatal	Retest radio by turning it off and turning it on again.
FAIL 02/88	DSP RAM test failure.	Fatal	Retest radio by turning it off and turning it on again.
FAIL 02/C0	DSP ROM Checksum is wrong.	Fatal	Retest radio by turning it off and turning it on again.
No Display	Display module is not connected properly. Display module is damaged.	Fatal	Check connection between main board and display module. Replace with new display module.



NOTICE:

If error message reoccurs, replace main board or send radio to nearest Motorola Solutions Depot.

6.3

Operational Error Codes

During radio operation, your radio performs dynamic tests to determine if your radio is working properly. Problems detected during these tests are presented as error codes on your radio display. Use the following table to aid in understanding particular operational error codes.

Table 40: Types of Error Code

Error Code	Description	Error Type	Corrective Action
FAIL 001	Synthesizer Out-of-Lock.	Non-fatal	Reprogram the codeplug. Refer to <i>Detailed Service Manual</i> .
FAIL 002	Personality checksum or system block error.	Non-fatal	Reprogram the codeplug.



NOTICE: If error message reoccurs, send radio to nearest Motorola Solutions Service Centers or Authorized Motorola Solutions Service Dealers.

Chapter 7

Authorized Accessories List

Motorola Solutions provides a list of accessories to improve the productivity of your radio.

Antenna

- VHF, 144–165 MHz, Helical Antenna (PMAD4116_)
- VHF, 136–155 MHz, Helical Antenna (PMAD4117_)
- VHF, 152–174 MHz, Helical Antenna (PMAD4118_)
- VHF, 136–148 MHz, Stubby Antenna (PMAD4119_)
- VHF, 146–160 MHz, Stubby Antenna (PMAD4120_)
- VHF, 160–174 MHz, Stubby Antenna (PMAD4121_)
- UHF, 403–450 MHz, Stubby Antenna (PMAE4069_)
- UHF, 440–490 MHz, Stubby Antenna (PMAE4070_)
- UHF, 470–527 MHz, Stubby Antenna (PMAE4071_)
- UHF, 403–527 MHz, Slim Whip Antenna (PMAE4079_)

Batteries

- Core Slim Li-Ion, 1600 mAh IP56 Battery (PMNN4406_R)
- IMPRES Slim Li-Ion, 1600 mAh IP56 Battery (PMNN4407_R)
- IMPRES Li-Ion Non-FM, 2250 mAh IP56 Battery (PMNN4409_R)
- Li-Mn 1400 mAh low temp -30 °C IP67 Submersible Battery (PMNN4435_R)⁹
- Battery Li-Ion, IP57 2050 mAh (PMNN4463_)⁹
- IMPRES Li-Ion, 3000 mAh IP68 Battery for Vibrating Belt Clip (PMNN4488_)
- IMPRES Li-Ion, 2900 mAh TIA4950 HAZLOC IP68 Battery (PMNN4490_)¹⁰
- IMPRES Slim Li-Ion, 2100 mAh IP68 Battery (PMNN4491_)
- IMPRES Li-Ion, 3000 mAh IP68 Battery, low voltage (PMNN4493_)
- Core Li-Ion, 2450 mAh IP68 Battery (PMNN4543_)
- IMPRES Li-Ion, 2450 mAh IP68 Battery (PMNN4544_)

Carry Devices

- Belt Clip for 2 in. Belt Width (PMLN4651_)
- 2.5 in. Replacement Leather Swivel Belt Loop (PMLN5610_)
- 3 in. Replacement Leather Swivel Belt Loop (PMLN5611_)
- Hard Leather Carry Case with 3 in. Fixed Belt Loop for Limited Keypad Radio (PMLN5863_)
- Hard Leather Carry Case with 3 in. Swivel Belt for Limited Keypad Radio (PMLN5865_)
- Hard Leather Carry Case with 2.5 in. Swivel Belt Loop for Limited Keypad Radio (PMLN5867_)

⁹ Your radio is compatible with the accessories listed here. Contact your dealer for details.

¹⁰ Applicable to XPR 3500e/XPR 3300e only.

- Nylon Carry Case with 3 in. Fixed Belt Loop for Limited Keypad Radio (PMLN5869_)
- Belt Clip for 2.5 in. Belt Width (PMLN7008_)
- Vibrating Belt Clip for 2.5 in. Belt Width (PMLN7296_)
- Leather Radio Strap (RLN6486_)⁹
- Leather Radio Strap, Size XL (RLN6487_)⁹
- Anti-Sway Leather Radio Strap (RLN6488_)⁹

Chargers

- U.S. Switch Mode Power Supply (EPNN9288_)
- IMPRES Battery Fleet Management License Key (HKVN4036_)
- IMPRES Battery Reader (NNTN7392_)
- IMPRES Vehicular Charger (NNTN7616_)
- IMPRES Battery Fleet Management Multi-Unit Charger Interface Unit (NNTN7677_)⁹
- Wall Mount Bracket for IMPRES Multi-Unit Charger (NLN7967_)⁹
- IMPRES Battery Fleet Management Single-Unit Charger Interface Unit (NNTN8045_)⁹
- Core Single Unit Charger (NNTN8117_)
- Standard Single-Unit Charger with Power Supply, Linear PRC (NNTN8224_)
- Standard Single-Unit Charger with Power Supply, Linear, 110 V ac US Plug (NNTN8226_)
- Standard Single-Unit Charger with Power Supply, Switch-Mode – 21 W, NA/LA (NNTN8275_)
- Travel Charger, Rapid Rate with Voltage Regulated Vehicular Charger Adapter, Custom Charger Base, Mounting Bracket, and Coil Cord (NNTN8525_)⁹
- IMPRES Multi-Unit Charger, Base Only (WPLN4211_)
- IMPRES Multi-Unit Charger, US/NA Plug (WPLN4212_)
- IMPRES Multi-Unit Charger with Display, Base Only (WPLN4218_)
- IMPRES Multi-Unit Charger with Display, US/NA Plug (WPLN4219_)
- IMPRES Single-Unit Charger with Switch Mode Power Supply (WPLN4232_)
- IMPRES Single-Unit Charger, Base Only (WPLN4243_)
- LTD Single-Unit Charger IMPRES (SMPS NA/LA) (WPLN4253_)

Earbuds and Earpieces

- Receive-Only Covered Earbud with Coiled Cord, for Remote Speaker Microphone (AARLN4885_)
- Earpiece 12 in. Cable, for use with Bluetooth POD (NTN2572_)
- Non-secure Wireless Accessory Kit, Operational Critical Wireless Earpiece, standard pair, 12 in. Cable (NNTN8125_)
- Non-secure Wireless Bluetooth Accessory Kit, Operational Critical Wireless Earpiece, 12 in. Cable, No Charger (NNTN8189_)
- Non-secure Operation Critical Wireless Earbud with 11.4 in. Cable (NNTN8294_)
- Non-secure Operational Critical Wireless Earbud with 45.7 in. Cable (NNTN8295_)
- Wireless Covert Kit, includes two sets of 2-Wire Earbuds (1 Black and 1 White), 1-Wire Earbud (Black), and a 3.5 mm Adapter to plug into any off-the-shelf headphones (NNTN8296_)
- Wireless Neckloop Y-adapter and retention hook for Completely Discreet Kit (NNTN8385_)

- D-Shell Receive-Only Earpiece (One Size) for Remote Speaker Microphone (PMLN4620_)
- Earpiece In-Line Mic/PTT Swivel, MagOne (PMLN5727_)
- Earset with Boom Microphone, MagOne (PMLN5732_)
- Earbud with In-Line Mic/PTT, MagOne (PMLN5733_)
- Adjustable D-Style with In-Line Mic and PTT (PMLN6757_)⁹
- MOTOTRBO Bluetooth Accessory Kit, Flexfit Earpiece with NA Power Supply (PMLN7181_)
- Flexible Fit Swivel Earpiece with Boom Microphone, Bluetooth Accessory Kit Pod, Multipack, pack of 3 (PMLN7203_)
- Adjustable Receive-Only Earpiece with Remote Speaker Microphone (PMLN7396_)
- Receive-Only Earpiece with Translucent Tube (PMLN7560_)
- Completely Discreet Earpiece Kit (PMLN7696_)
- Receive-Only Earpiece with Translucent Tube and Rubber Eartip for Remote Speaker Microphone (RLN4941_)
- Non-secure Wireless Accessory Kit (PMLN6462_)
- Bluetooth Accessory Kit with NA Power Supply (RLN6500_)
- Bluetooth Accessory Kit Argentina (RLN6502_)
- Bluetooth Accessory Kit with Euro Plug (RLN6503_)
- Bluetooth Accessory Kit Brazil (RLN6504_)
- Clear EP7-Small Hearing Protectors [Sonic Defenders] Ultra Earplugs, Noise reduction = 28 dB (RLN6511_)⁹
- Clear EP7-Medium Hearing Protectors [Sonic Defenders] Ultra Earplugs, Noise reduction = 28 dB (RLN6512_)⁹
- Clear EP7-Large Hearing Protectors [Sonic Defenders] Ultra Earplugs, Noise reduction = 28 dB (RLN6513_)⁹
- Swivel Earpiece with In-line Microphone, Bluetooth Accessory Kit Pod, pack of 3 (RLN6550_)
- Receive-Only Flexible Earpiece for Remote Speaker Microphone (WADN4190_)

Headsets and Headset Accessories

- Heavy Duty Headset, Noise Cancelling with In-Line PTT (PMLN5731_)
- Lightweight Over-the-Head Headset Single Muff with In-line Push-to-Talk and Boom Microphone (PMLN6635_)
- Temple Transducer (PMLN6759_)⁹
- Next Generation Behind-the-Head Heavy Duty Headset, Slim (PMLN6760_)
- Breeze Headset, Magone (PMLN6761_)⁹
- Next Generation Behind-the-Head Heavy Duty Headset, Slim TIA 4950 (PMLN6763_)⁹
- Over-the-Head Heavy Duty Headset, Slim (PMLN7464_)
- Over-the-Head Heavy Duty Headset/TIA, Slim (PMLN7465_)
- XBT Behind-the-Neck, Non-secure Wireless Heavy Duty Headset (RLN6490_)
- XBT Overhead, Non-secure Wireless Heavy Duty Headset (RLN6491_)

Remote Speaker Microphones

- IMPRES Remote Speaker Microphone Large, Noise Cancelling with 3.5 mm Jack (PMMN4071_)

- IMPRES Remote Speaker Microphone Small, with 3.5 mm Jack (PMMN4073_)
- Remote Speaker Microphone Small, No Emergency, IP57 (PMMN4075_)
- Remote Speaker Microphone Small with 3.5 mm Jack (PMMN4076_)
- IMPRES Remote Speaker Microphone Windporting, IP67 (PMMN4108_)

Surveillance Accessories

- 3-Wire Surveillance Kit with Quick Disconnect Adapter and Clear Acoustic Tube, Black (PMLN6754_)
- 3-Wire Surveillance Kit with Quick Disconnect Adapter and Clear Acoustic Tube, Beige (PMLN6755_)
- Operations Critical Wireless 1-Wire Surveillance Kit with Translucent Tube (PMLN7052_)
- 2-Wire Surveillance Kit with Quick Disconnect Clear Acoustic Tube, Black (PMLN7269_)
- 2-Wire Surveillance Kit with Quick Disconnect Clear Acoustic Tube, Beige (PMLN7270_)

Miscellaneous Accessories

- Universal Chest Pack (HLN6602_)
- Waterproof Bag, Includes Large Carry Strap (HLN9985_)
- Adjustable Black Nylon Carrying Strap (Attaches to D-Ring on Carry Case) (NTN5243_)
- Small Clip, Epaulet Strap (RLN4295_)
- Break-A-Way Chest Pack (RLN4570_)
- Universal Radio Pack and Utility Case (Fanny Pack) (RLN4815_)
- Replacement Strap for RLN4570_ and HLN6602_ (1505596Z02)
- Universal RadioPAK Extension Belt (4280384F89)
- 1.75 in. Wide Leather Belt (4200865599)

Chapter 8

Replacement Parts Ordering

Basic Ordering Information

Some replacement parts, spare parts, and/or product information can be ordered directly on Motorola Solutions local distribution organization or through Motorola Online. While parts may be assigned with a Motorola Solutions part number, this does not guarantee that they are available from Motorola Solutions Radio Products and Solutions Organization (RPSO). Some parts may have become obsolete and no longer available in the market due to cancelations by the supplier. If no Motorola Solutions part number is assigned, the part is normally not available from Motorola Solutions, or is not a user-serviceable part. Part numbers appended with an asterisk are serviceable by Motorola Solutions Depot only.

Orders for replacement parts, kits, and assemblies should be placed directly on Motorola Solutions local distribution organization or through Motorola Online. When ordering replacement parts or equipment information, the complete identification number should be included. This applies to all components, kits, and chassis. If the component part number is not known, the order should include the number of the chassis or kit of which it is a part, and sufficient description of the desired component to identify it.

Request for help in identification if non-referenced spare parts should be directed to the Customer Care organization of Motorola Solutions local area representation. Orders for replacement parts, kits, and assemblies should be placed directly on Motorola Solutions local distribution organization or by using Motorola Online.

Motorola Online

Motorola Online users can access our online catalog at <https://businessonline.motorolasolutions.com>.

To register for online access:

Please call 1-800-422-4210 (for U.S. and Canada Service Centers only). International customers can obtain assistance at <https://businessonline.motorolasolutions.com>.

Types of Orders

Mail Orders

Mail orders are only accepted by the U.S. Federal Government Markets Division (USFGMD).

Motorola
Solutions
7031 Columbia Gateway Drive
3rd Floor - Order Processing
Columbia, MD 21046
U.S.A.

Telephone Orders and Parts Identification

- RPSO
(United States and Canada)
7:00 AM to 7:00 PM (Central Standard Time)
-

Types of Orders

	Monday through Friday (Chicago, U.S.A.) 1-800-422-4210 1-847-538-8023 (United States and Canada)
	• USFGMD 1-800-826-1913 Federal Government Parts - Credit Cards Only 8:30 AM to 5:00 PM (Eastern Standard Time)
Fax Orders	RPSO (United States and Canada) 1-800-622-6210 1-847-576-3023 (United States and Canada) USFGMD (Federal Government Orders) 1-800-526-8641 (For Parts and Equipment Pur- chase Orders)

Product Customer Service

RPSO (United States and Canada)

1-800-927-2744



NOTICE: The Motorola Solutions RPSO was formerly known as the Radio Products Services Division (RPSD) and/or the Accessories and Aftermarket Division (AAD).

Chapter 9

Motorola Solutions Service Centers

If a unit requires further testing, knowledge and/or details of component level troubleshooting or service than is customarily performed at the basic level, please send the radio to a Motorola Solutions Service Center as listed below.

Types of Center	Address	Telephone Number
Motorola Solutions Service Centers	1220 Don Haskins Drive Suite A El Paso, TX 79936	915-872-8200
Motorola Solutions Federal Technical Center	10105 Senate Drive Lanham, MD 20706	1800-969-6680 Fax: 1800-784-4113
Motorola Solutions Canadian Technical Logistics Center	181 Whitehall Drive Markham, Ontario L3R 9T1	Toll Free: 1-800-543-3222

Chapter 10

Limited Level 3 Servicing

Only Motorola Solutions Service Center or Motorola Solutions Authorized Dealers can perform Limited Level 3 Servicing.

Refer to "Disassembly/Reassembly Procedures" chapter for details of the following:

- Preventive maintenance (inspection and cleaning).
- Safe handling of CMOS and LDMOS devices.
- Repair procedures and techniques.

For soldering components with Hot-Air or infra red solder systems, check the *User Guide* of your solder system to get information on solder temperature and time for the different housings of the integrated circuits and other components.

10.1
Component and Parts List

Figure 66: PCB Top View

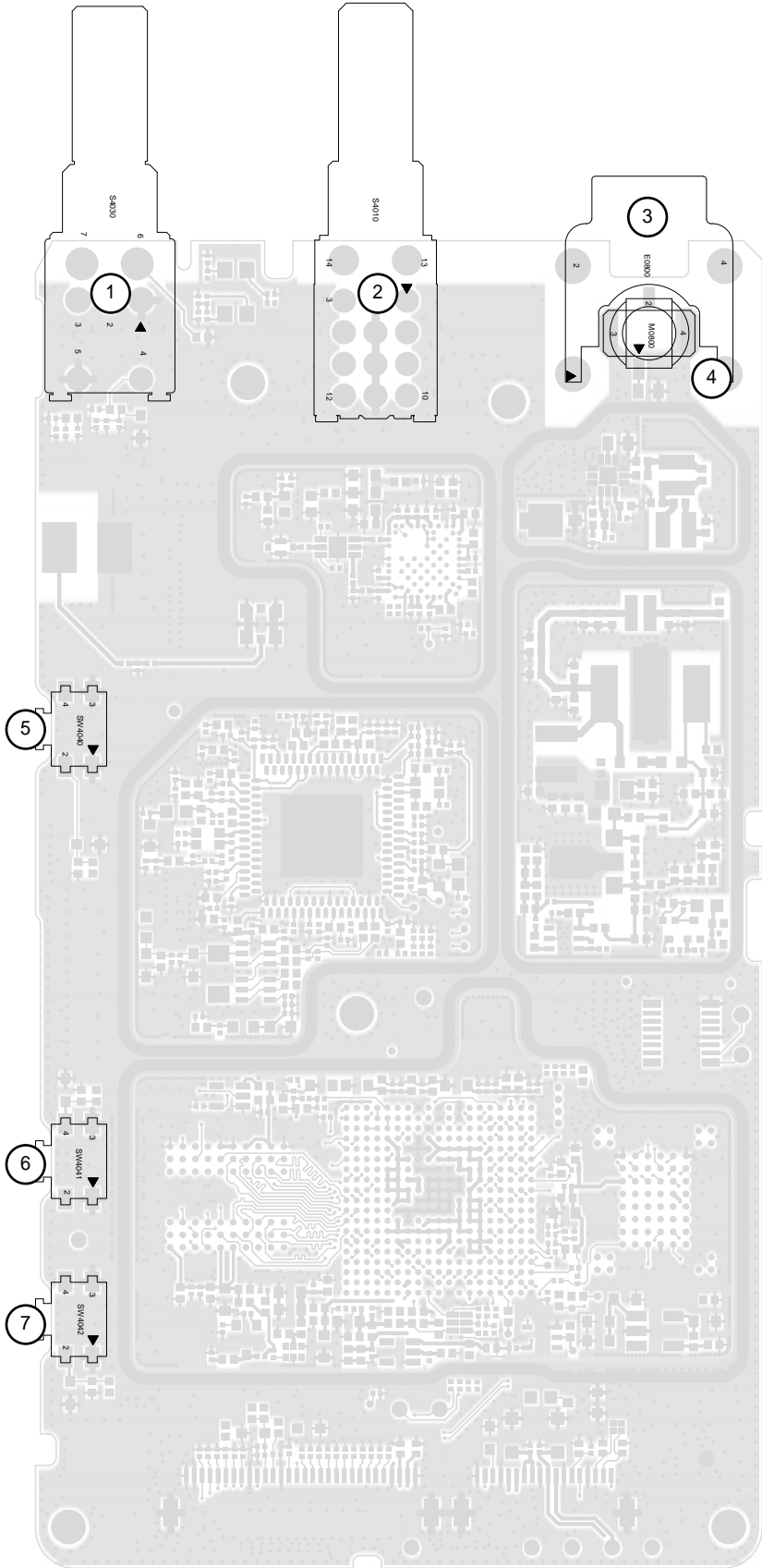

Figure 67: PCB Bottom View

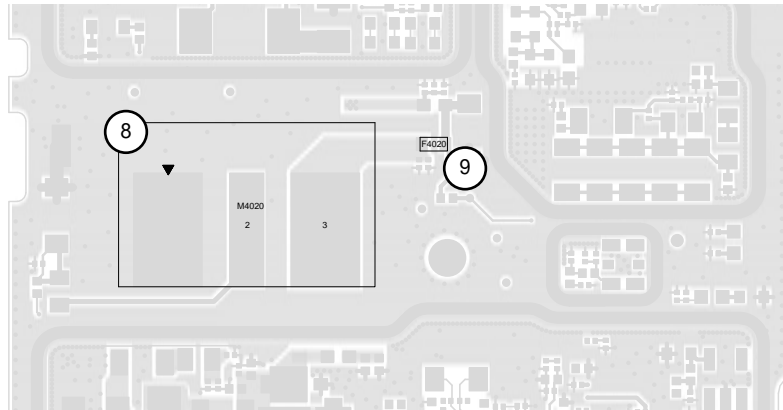

Table 41: Component Parts List

No.	Circuit Ref	Motorola Solutions Part Number	Description
1	S4030	1875103C04	Potentiometer, Rotary On/Off Switch
2 ¹¹	S4010	40012023001	Frequency Switch (Endless)
		40012029001	Frequency Switch (Stopper)
3	E0800	02012010003	Connector RF
4	M0800	0987378K01	Conn RF Mod3
5	SW4040	4070354A01	SW:SM, SPST50, 12, Push-On Type*
6	SW4041	4070354A01	SW:SM, SPST50, 12, Push-On Type*
7	SW4042	4070354A01	SW:SM, SPST50, 12, Push-On Type*
8	M4020	0915184H01	Connector Battery Contact
9	F4020	65012019001	Fuse Chip SMT 3A

¹¹ There are two models for the frequency switch, Endless and Stopper. Follow the correct switch during servicing.

Glossary

This glossary contains an alphabetical listing of terms and their definitions that are applicable to portable and mobile subscriber radio products. All terms do not necessarily apply to all radios, and some terms are merely generic in nature.

Analog Refers to a continuously variable signal or a circuit or device designed to handle such signals.

Band Frequencies allowed for a specific purpose.

Bluetooth (BT) A wireless protocol utilizing short-range communications over short distances.

Customer Programming Software (CPS) Software with a graphical user interface containing the feature set of a radio.

Default A pre-defined set of parameters.

Digital Refers to data that is stored or transmitted as a sequence of discrete symbols from a finite set; most commonly this means binary data represented using electronic or electromagnetic signals.

Digital Private-Line (DPL) A type of digital communications that utilizes privacy call, as well as memory channel and busy channel lock out to enhance communication efficiency.

Federal Communications Commission (FCC) Regulates interstate and international communications by radio, television, wire, satellite and cable in all 50 states, the District of Columbia, and U.S. territories. It was established by the Communications Act of 1934 and operates as an independent U.S. government agency overseen by Congress. The commission is committed to being a responsive, efficient and effective agency capable of facing the technological and economic opportunities of the new millennium.

Frequency Number of times a complete electromagnetic-wave cycle occurs in a fixed unit of time (usually one second).

General-Purpose Input/Output (GPIO) Pins whose function is programmable.

Integrated Circuit (IC) An assembly of interconnected components on a small semiconductor chip, usually made of silicon. One chip can contain millions of microscopic components and perform many functions.

kilohertz (kHz) One thousand cycles per second. Used especially as a radio-frequency unit.

Liquid-Crystal Display (LCD) An LCD uses two sheets of polarizing material with a liquid-crystal solution between them. An electric current passed through the liquid causes the crystals to align so that light cannot pass through them.

Light Emitting Diode (LED) An electronic device that lights up when electricity is passed through it.

Motorola Digital Communications (MDC) A Motorola Solutions proprietary signaling scheme permitting the transfer of data communications at the rate of 1200 bits per second. Designed specifically for high reliability in the land-mobile radio environment. Digital encoding allows a much greater amount of information to pass over the channel with each message than with alternative tone encoding methods. Some features include: PTT ID, Emergency, Call Alert, Emergency Alarm, Voice Selection Call (SelCall), Radio Check, and Monitor.

Megahertz (MHz) One million cycles per second. Used especially as a radio-frequency unit.

Paging One-way communication that alerts the receiver to retrieve a message.

Printed Circuit Board (PC Board) A circuit manufactured so that many or all of the components are attached to a non-conductive circuit board with copper strips on one or both sides to replace wires.

Private-Line Tone Squelch (PL) A continuous sub-audible tone that is transmitted along with the carrier.

Programming Cable A cable that allows the CPS to communicate directly with the radio using USB.

Receiver Electronic device that amplifies RF signals. A receiver separates the audio signal from the RF carrier, amplifies it, and converts it back to the original sound waves.

Repeater Remote transmit/receive facility that re-transmits received signals in order to improve communications range and coverage (conventional operation).

Radio Frequency (RF) The portion of the electromagnetic spectrum between audio sound and infrared light (approximately 10 kHz to 10 GHz).

Signal An electrically transmitted electromagnetic wave.

Spectrum Frequency range within which radiation has specific characteristics.

Squelch Muting of audio circuits when received signal levels fall below a pre-determined value. With carrier squelch, all channel activity that exceeds the radio's preset squelch level can be heard.

Time-out Timer (TOT) A timer that limits the length of a transmission.

Tone Private Line (TPL) A continuous tone-coded squelch, which contains 29 codes. It is not compatible with DPL, and is common among all radio manufacturers.

Transceiver Transmitter-receiver: A device that both transmits and receives analog or digital signals. Also abbreviated as XCVR.

Transmitter Electronic equipment that generates and amplifies an RF carrier signal, modulates the signal, and then radiates it into space.

Ultra-High Frequency (UHF) The term for the International Telecommunication Union (ITU) Radio Band with a frequency range of 300 to 3000 MHz.

Universal Serial Bus (USB) An external bus standard that supports data transfer rates of 12 Mbps.